

MILBANK[®]
ENERGY AT WORK



New England

Area Catalog



Milbank Overview

Energy At Work since 1927

Milbank designs and manufactures electrical solutions that move and manage power for the residential, commercial, industrial, utility and transportation sectors. With more than 90 years of expertise in electrical engineering design and manufacturing, Milbank's portfolio includes metering equipment, enclosures and enclosed controls. Founded in 1927, Milbank is a family-owned, American manufacturer headquartered in Kansas City, Mo. For more information, please visit milbankworks.com.



METERING

As a market leader in electrical metering equipment, Milbank has set the standard for quality since 1927. Hundreds of configurations are available, including many sizes, knockout configurations, Terminals configurations, bypass options, hubs, locks and connectors. Milbank has the socket you need with thousands of active products to meet your utility's requirements.



ENCLOSURES

Milbank's line of enclosures include commercial junction boxes, panel mount enclosures, transformer cabinets, wireway and troughs. Built with high-quality craftsmanship and materials which meet or exceed industry standards, Milbank enclosures are made to protect controls and equipment from dust, dirt and other harmful elements found in a wide variety of environments based on various NEMA ratings Milbank offers.



ENCLOSED CONTROLS

Milbank doesn't just build empty enclosures. We can deliver the entire package, complete with custom control equipment built to your exact specifications by our engineers. Milbank enclosed controls are an attractive, secure, easy-to-install and cost-effective solution when underground remote site power distribution and control equipment is required, replacing unsightly and inefficient strut and backboard structures.



Please consult serving utility for their requirements prior to ordering or installing, as specifications and approvals vary by utility, and may require local electrical inspector approval. All installations must be installed by a licensed electrician and must comply with all national and local codes, laws and regulations. Milbank reserves the right to make changes in specifications and features shown without notice or obligation.

Air Conditioner Disconnects

30-60 Amps AC disconnects	6
60 Amps AC disconnect with 20 Amps GFCI receptacle.....	7
Hot tub disconnects.....	8

Single Position Sockets

100 Amps, 4 terminals, ringless, solar	9
125-200 Amps, 4 terminals, ringless.....	10-12
125 Amps, 5 & 7 terminals, medium duty lever bypass, ringless.....	13
200 Amps, 5 terminals, medium duty lever bypass, ringless	14
200 Amps, 4 terminals, heavy duty lever bypass, ringless.....	15
200 Amps, 5 & 7 terminals, heavy duty lever bypass, ringless	16-17
320 Amps, 4, 5 & 7 terminals, heavy duty lever bypass, ringless	18-19

Meter Mains

100-200 Amps, 4 terminals, ringless.....	20
100-200 Amps, 4 terminals, lever bypass, ringless	21
100-200 Amps, 4 terminals, with load center, ringless	22
100-200 Amps, 4 & 7 terminals, lever bypass, ringless.....	23
320 Amps, 4 & 7 terminals, lever bypass, ringless.....	24-26
200 & 400 Amps, 7 terminals, cold sequence, lever bypass, ringless	27

Multi-Position

100 Amps, 4 terminals, ringless & ring type, vertical.....	28
100 Amps, 4 terminals, ringless.....	29
100-200 Amps, 4 terminals, ringless.....	30-31
125 Amps, 4 terminals, with single position lever bypass, ringless	32
100 Amps, 5 terminals, lever bypass, ringless, vertical.....	33
100-200 Amps, 5 terminals, lever bypass, ringless	34-35
200 Amps, 7 terminals, lever bypass, ringless	36

Multi-Position Meter Mains

125 Amps, 4 terminals, with single position lever, ringless	37
125 & 200 Amps, 4 terminals, ringless	38-39
125 & 200 Amps, 5 terminals, lever bypass, ringless.....	40-42
200 Amps, 5 terminals, lever bypass, ringless	43-45

Please consult serving utility for their requirements prior to ordering or installing, as specifications and approvals vary by utility, and may require local electrical inspector approval. All installations must be installed by a licensed electrician and must comply with all national and local codes, laws and regulations. Milbank reserves the right to make changes in specifications and features shown without notice or obligation.



Transformer Rated

20 Amps, 6-13 terminals, plunger bypass, ringless.....	46-48
Test switches	49
CT cabinets	50
Test cabinet	51

Polyphase Enclosures

A base enclosures	52
-------------------------	----

Pedestals

Meter pedestal for pad-mounting	53
200 Amps, 4 terminals, direct bury.....	54
200 Amps, 4 terminals, with meter main with load center	55-56
100-200 Amps, 5 terminals, with meter main with load center	57

Temp Power Units

125, 4 terminals, ringless.....	58
---------------------------------	----

Parts & Accessories

Circuit breakers and accessories.....	59-63
---------------------------------------	-------

Miscellaneous

Tap box.....	64
Enclosed controls.....	65-74
RV products	75
Commercial enclosures	76
Reference information	77-81
Index.....	82



Please consult serving utility for their requirements prior to ordering or installing, as specifications and approvals vary by utility, and may require local electrical inspector approval. All installations must be installed by a licensed electrician and must comply with all national and local codes, laws and regulations. Milbank reserves the right to make changes in specifications and features shown without notice or obligation.

Catalog Number Logic

How our product catalog numbers are derived

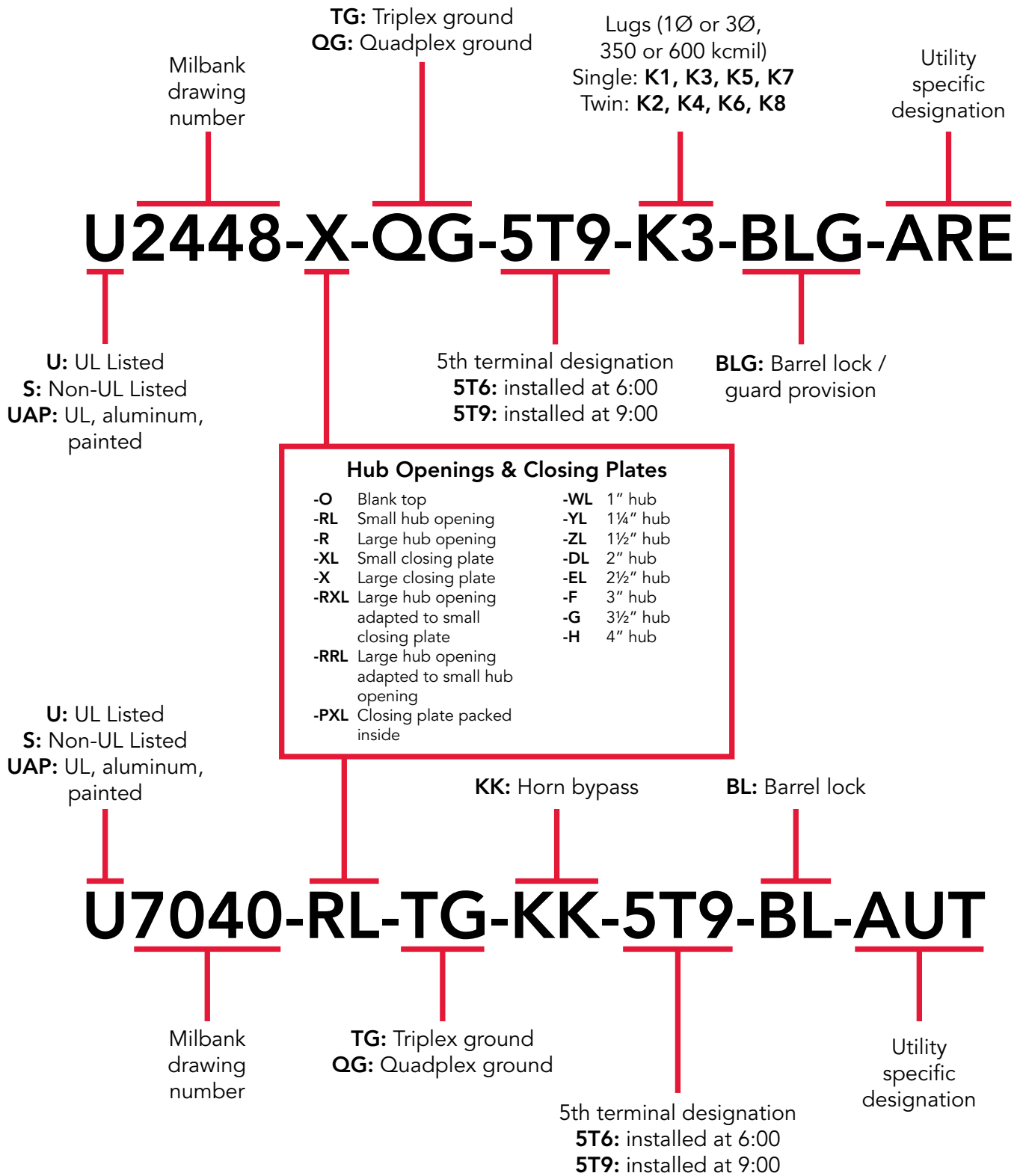

Please consult serving utility for their requirements prior to ordering or installing, as specifications and approvals vary by utility, and may require local electrical inspector approval. All installations must be installed by a licensed electrician and must comply with all national and local codes, laws and regulations. Milbank reserves the right to make changes in specifications and features shown without notice or obligation.





U3802



U3812



U3832

Milbank's air conditioner disconnect has a removable hinged cover that makes wiring a breeze. Our compact design meets NEC wiring space requirements and also complies with NEC article 440-14. For safe working conditions, our disconnect pullers may be removed and reinstalled in the OFF position. Additionally, padlock provisions are included on the front cover. As with other Milbank products, our enclosure is constructed of G90U galvanized steel and electrostatically finished with an attractive, light gray, baked powder coating. Our epoxy/polyester resin blend offers a finish that is both durable and fade-resistant.

30-60 Amps | Air Conditioner Disconnects | 1Ø 240 VAC

Catalog Number	Amps	Type	Max H.P.	Weight (lbs.)	Line/Load Wire Range		Ground Wire Range CU/AL	Dimensions			Wire Rating	
					CU	AL		D"	W"	H"	CU °C	AL °C
U3802	60	Non-Fusible	10	3.25	#14-#2	#12-#2	#14-4	2½	5	7½	60°/75°	60°/75°
U3812	60	Non-Auto	10	3.25	#14-#2	#12-#2	#14-4	2½	5	7½	60°/75°	60°/75°
U3832	30	Fusible	3	2.5	#14-#3	#14-#3	#14-3	2½	5	7	60°/75°	60°
U3862	60	Fusible	10	3.3	#14-#3	#14-#3	#14-3	2½	5	9	60°/75°	60°/75°

Notes

- UL listed as Enclosed Pullout Switch
- NEMA 3R
- Weather resistant
- 1-inch concentric knockouts



Please consult serving utility for their requirements prior to ordering or installing, as specifications and approvals vary by utility, and may require local electrical inspector approval. All installations must be installed by a licensed electrician and must comply with all national and local codes, laws and regulations. Milbank reserves the right to make changes in specifications and features shown without notice or obligation.

Air Conditioner Disconnects

60 Amps | With 20 Amps GFCI Receptacle



U3822-20GWR

Specifications

- Meets NEC #406.8 requirements
- Meets NEC #210.63 requirements
- UL listed as Power Outlet
- NEMA 3R
- In-use cover*
- Duplex ground connector
- 1-inch concentric knockouts
- 1Ø, 240 VAC
- 60 Amps, non-fused
- 20 Amps GFCI receptacle
- Reset/test button
- Weather resistant

60 Amps | Air Conditioner Disconnect with 20 Amps GFCI Receptacle | 1Ø, 240 VAC

Catalog Number	Type	Max H.P.	Weight (lbs.)	Line/Load Wire Range		Ground Wire Range CU/AL	Dimensions			Wire Rating	
				CU	AL		D"	W"	H"	CU °C	AL °C
U3822-20GWR	Non-Fusible	10	6	#14-#2	#12-#2	#14-4	4 ⁴ / ₅	5 ¹ / ₄	7 ⁷ / ₅	60°/75°	60°/75°

Notes

- **Disconnect Pullers:** To ensure the safest conditions, Milbank disconnect pullers are reversible so they may be reinstalled in the OFF position.
 - **Padlock Provision:** All units are designed with a padlock provision on the cover for security.
- *Rated as an in-use cover (cover may be closed with cords plugged into receptacle).

Please consult serving utility for their requirements prior to ordering or installing, as specifications and approvals vary by utility, and may require local electrical inspector approval. All installations must be installed by a licensed electrician and must comply with all national and local codes, laws and regulations. Milbank reserves the right to make changes in specifications and features shown without notice or obligation.





U4881-O-50GB



U4881-O-60GB

Specifications

- 240 VAC ground fault protection
- UL listed
- NEMA 3R
- Weather resistant
- 2-pole, 50 or 60 Amps GFCI breaker protection
- Compact size
- Three or four wire installation
- 1Ø, 120/240 VAC
- Standard package of 12
- Two extra 1-pole breaker spaces
- 100 Amps overall rating
- Easy to install

100 Amps | NEMA 3R

Catalog Number	Breaker Amps	Type	Weight (lbs.)	Line/Load Wire Range		Ground Wire Range CU/AL	Dimensions		
				CU	AL		D"	W"	H"
U4881-O-50GB	50	Breaker	8	#14-1/0	#14-1/0	#14-1/0	3¾	7½	8½
U4881-O-60GB	60	Breaker	8	#14-1/0	#14-1/0	#14-1/0	3¾	7½	8½



Please consult serving utility for their requirements prior to ordering or installing, as specifications and approvals vary by utility, and may require local electrical inspector approval. All installations must be installed by a licensed electrician and must comply with all national and local codes, laws and regulations. Milbank reserves the right to make changes in specifications and features shown without notice or obligation.

Single Position Sockets

100 Amps | 4 Terminals | Ringless | 600 VAC

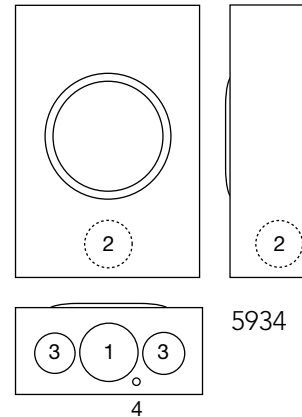

U5934-XL-BLG

100 Amps | 4 Terminals | Ringless | 1Ø3W

Catalog Number	Service	Hub	Connectors CU/AL		Bypass	Dimensions			Knockouts			
			Line	Load		D"	W"	H"	1	2	3	4
U5934-XL-BLG	OH/UG	C.P.	#12-1/0	#12-1/0	None	3 ⁵ / ₁₆	8	11 ¹ / ₂	2	1 ¹ / ₂	1 ¹ / ₄	1 ¹ / ₄

Notes

- **Hubs:** Accepts standard meter socket hubs.
- **Construction:** Units are NEMA 3R for durable outdoor use, lockable and sealable.
- **Connectors:** Connectors will accept #14-1/0 conductors.
- **Isolated Neutral:** To isolate neutral remove bonding screw.



Please consult serving utility for their requirements prior to ordering or installing, as specifications and approvals vary by utility, and may require local electrical inspector approval. All installations must be installed by a licensed electrician and must comply with all national and local codes, laws and regulations. Milbank reserves the right to make changes in specifications and features shown without notice or obligation.



1 □

Single Position Sockets

125 Amps | 4 Terminals | Ringless | 600 VAC



U7487-O-TG

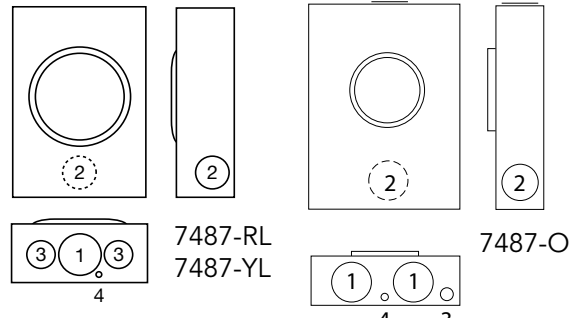

125 Amps | 4 Terminals | Ringless | Single Position | 1Ø3W

Catalog Number	Service	Hub	Connectors CU/AL		Bypass	Dimensions			Knockouts			
			Line	Load		D"	W"	H"	1	2	3	4
U7487-YL-TG	OH	1¼	#6-2/0	#6-2/0	None	3⅝	8	11½	2	1½	1¼	¼
U7487-RL-TG	OH/UG	H.O.	#6-2/0	#6-2/0	None	3⅝	8	11½	2	1½	1¼	¼
U7487-O-TG	UG	Blank	#6-2/0	#6-2/0	None	3⅝	8	11½	2	1½	¼, ½	¼

Notes

- **Hubs:** For proper hub selection, see the hub suffix chart on the accessories page.
- **Fifth Terminal:** For field-installable fifth terminal order catalog number 5T8K2.
- **Connectors:** Extruded aluminum connectors are tin plated.
- **Ground:** Units are supplied with a triplex ground (-TG).



Please consult serving utility for their requirements prior to ordering or installing, as specifications and approvals vary by utility, and may require local electrical inspector approval. All installations must be installed by a licensed electrician and must comply with all national and local codes, laws and regulations. Milbank reserves the right to make changes in specifications and features shown without notice or obligation.

Single Position Sockets

1 1

200 Amps | 4 Terminals | Ringless | 600 VAC

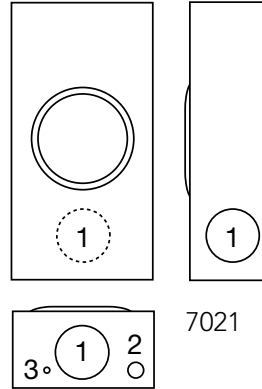

U7021-RL-TG

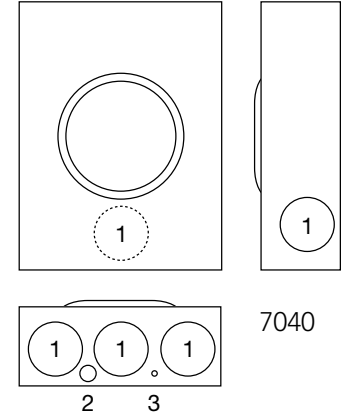

U7040-O-TG

200 Amps | 4 Terminals | Ringless | Single Position | 1Ø3W

Catalog Number	Service	Hub	Connectors CU/AL	Bypass	Dimensions			Knockouts			
					D"	W"	H"	1	2	3	4
U7021-RL-TG	OH	H.O.	#6-350	None	4 $\frac{1}{8}$	8	15 $\frac{1}{2}$	2 $\frac{1}{2}$	$\frac{1}{4}$, $\frac{1}{2}$	$\frac{1}{4}$	—
U7040-XL-TG	OH/UG	C.P.	#6-350	None	4 $\frac{1}{8}$	11	15 $\frac{1}{2}$	2 $\frac{1}{2}$	$\frac{1}{4}$, $\frac{1}{2}$	$\frac{1}{4}$	—
U7040-O-TG	UG	Blank	#6-350	None	4 $\frac{1}{8}$	11	15 $\frac{1}{2}$	2 $\frac{1}{2}$	$\frac{1}{4}$, $\frac{1}{2}$	$\frac{1}{4}$	—

Notes

- **Hubs:** For proper hub selection, see the hub suffix chart on the Accessories page.
- **Fifth terminal:** For field-installable, fifth terminal, order **K5T**.
- **Ground:** Units supplied with triplex ground.
- **Connectors:** Extruded aluminum connectors are tin plated.

Please consult serving utility for their requirements prior to ordering or installing, as specifications and approvals vary by utility, and may require local electrical inspector approval. All installations must be installed by a licensed electrician and must comply with all national and local codes, laws and regulations. Milbank reserves the right to make changes in specifications and features shown without notice or obligation.



1 2

Single Position Sockets

200 Amps | 4 Terminals | Side Wireway | 600 VAC



U1980-O



U4413-O-BL



U5777-O

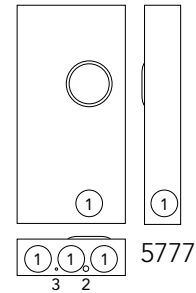
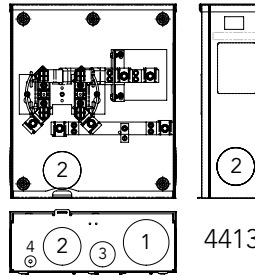
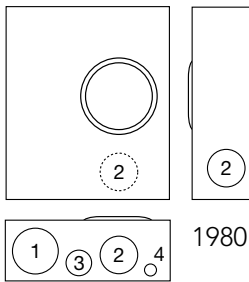

200 Amps | 4 Terminals | Ringless | Side Wireway | Single Position | 1Ø3W

Catalog Number	Service	Hub	Connectors CU/AL		Bypass	Dimensions			Knockouts			
			Line	Load		D"	W"	H"	1	2	3	4
U1980-O	UG	Blank	#6-350	#6-350	None	4½	13	15½	3	2½	¾	¼, ½
U4413-O-BL	UG	Blank	#6-350	#6-350	None	4½	13	15½	3	2½	¾	¼, ½
U5777-O	UG	Blank	¾-16 Studs	#2-350	None	4⅞	13	19	3	2½	¼, ½	¼

Notes

- **Hubs:** For proper hub selection, see the hub suffix chart on the accessories page.
- **Fifth Terminal:** For field-installable fifth terminal, order **K5T**.
- **Connectors:** Extruded aluminum connectors are tin plated.
- **Ground:** Units supplied with triplex ground.



Please consult serving utility for their requirements prior to ordering or installing, as specifications and approvals vary by utility, and may require local electrical inspector approval. All installations must be installed by a licensed electrician and must comply with all national and local codes, laws and regulations. Milbank reserves the right to make changes in specifications and features shown without notice or obligation.

Single Position Lever Bypass

1 3

125 Amps | 5 & 7 Terminals | Ringless | 600 VAC

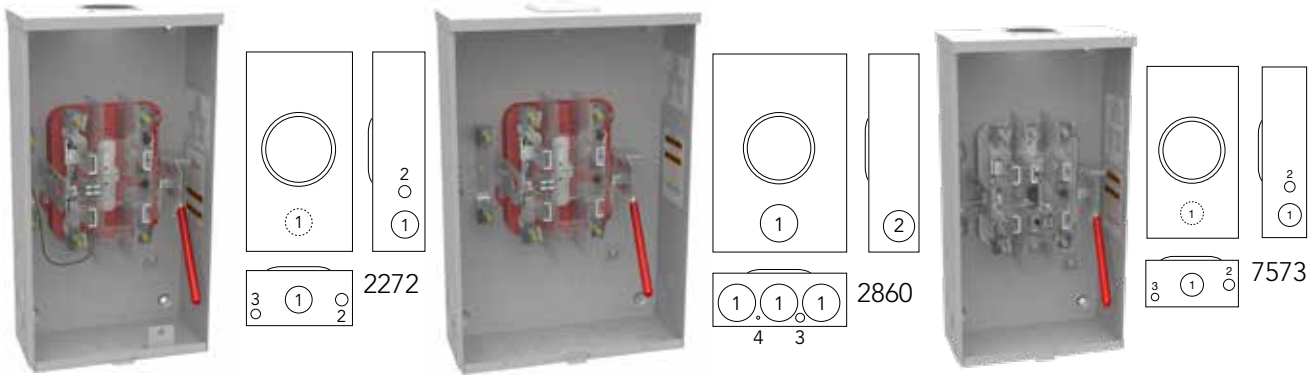

U2272-RL-5T9-BL

U2860-XL-5T9-QG

U7573-RL

125 Amps | 5 Terminals | Lever Bypass | Ringless | 1Ø3W

Catalog Number	Service	Hub	Connectors CU/AL		Bypass	Dimensions			Knockouts			
			Line	Load		D"	W"	H"	1	2	3	4
U2272-RL-5T9-BL	OH	H.O.	#6-2/0	#6-2/0	Lever	4 $\frac{7}{8}$	10	18 $\frac{1}{2}$	2	$\frac{3}{4}$	$\frac{1}{4}, \frac{1}{2}$	—
U2860-XL-5T9-QG	OH/UG	C.P.	#6-2/0	#6-2/0	Lever	4 $\frac{7}{8}$	13	19	3	2 $\frac{1}{2}$	$\frac{1}{4}, \frac{1}{2}$	$\frac{1}{4}$

Notes

- **Hubs:** For proper hub selection, see the hub suffix chart on the accessories page.
- **Fifth Terminal:** Factory installed in 9 o'clock position.
- **Lever Bypass:** The lever operates bypass device only; it is not jaw clamping (medium duty).
- **Connectors:** Extruded aluminum connectors are tin plated.

125 Amps | 7 Terminals | Lever Bypass | Ringless | 3Ø4W

Catalog Number	Service	Hub	Connectors CU/AL		Bypass	Dimensions			Knockouts		
			Line	Load		D"	W"	H"	1	2	3
U7573-RL	OH	H.O.	#6-2/0	#6-2/0	Lever	4 $\frac{7}{8}$	10	18 $\frac{1}{2}$	2	$\frac{3}{4}$	$\frac{1}{4}, \frac{1}{2}$

Notes

- **Hubs:** For proper hub selection, see the hub suffix chart on the accessories page.
- **Lever Bypass:** The lever operates bypass device only; it is not jaw clamping (medium duty).
- **Connectors:** Extruded aluminum connectors are tin plated.

Please consult serving utility for their requirements prior to ordering or installing, as specifications and approvals vary by utility, and may require local electrical inspector approval. All installations must be installed by a licensed electrician and must comply with all national and local codes, laws and regulations. Milbank reserves the right to make changes in specifications and features shown without notice or obligation.



Single Position Lever Bypass

200 Amps | 5 Terminals | Ringless | 600 VAC

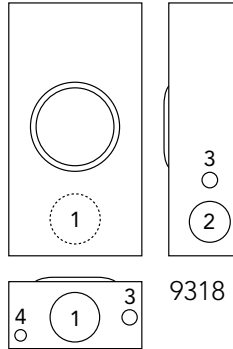

U9318-RL

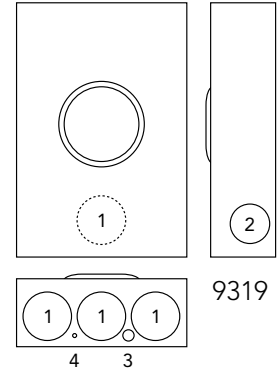

U9319-XL

200 Amps | 5 Terminals | Ringless | Single Position | 1Ø3W

Catalog Number	Service	Hub	Connectors CU/AL	Bypass	Dimensions			Knockouts				
					D"	W"	H"	1	2	3	4	5
U9318-RL	OH	H.O.	#6-350	Lever	4 $\frac{7}{8}$	10	18 $\frac{1}{2}$	3	2 $\frac{1}{2}$	$\frac{3}{4}$	1 $\frac{1}{4}$, 1 $\frac{1}{2}$	—
U9319-XL	OH/UG	C.P.	#6-350	Lever	4 $\frac{1}{8}$	13	19	3	2 $\frac{1}{2}$	1 $\frac{1}{4}$, 1 $\frac{1}{2}$	1 $\frac{1}{4}$	—

Notes

- **Hubs:** For proper hub selection, see the hub suffix chart on the accessories page.
- **Lever Bypass:** The lever operates bypass device only; it is not jaw clamping (medium duty).
- **Connectors:** Extruded aluminum connectors are tin plated.



Please consult serving utility for their requirements prior to ordering or installing, as specifications and approvals vary by utility, and may require local electrical inspector approval. All installations must be installed by a licensed electrician and must comply with all national and local codes, laws and regulations. Milbank reserves the right to make changes in specifications and features shown without notice or obligation.

Single Position Lever Bypass

15

200 Amps | 4 Terminals | Ringless | 600 VAC



U9800-RRL-QG-BL-NE

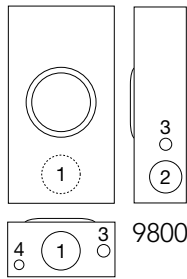

U9801-RXL-QG

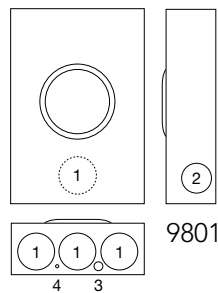

U3924-XL

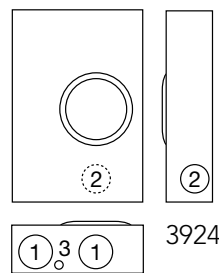

U4721-O-BL

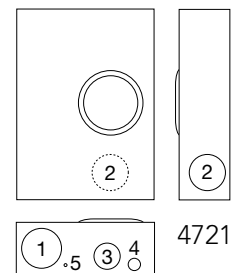

200 Amps | 4 Terminals | Ringless | Single Position | 1Ø3W

Catalog Number	Service	Hub	Connectors CU/AL	Bypass	Dimensions			Knockouts				
					D"	W"	H"	1	2	3	4	5
U9800-RRL-QG-BL-NE	OH	H.O.	#6-350	Lever	4 $\frac{7}{8}$	10	18 $\frac{1}{2}$	3	2 $\frac{1}{2}$	$\frac{3}{4}$	$\frac{1}{4}, \frac{1}{2}$	—
U9801-RXL-QG	OH/UG	C.P.	#6-350	Lever	4 $\frac{7}{8}$	13	19	3	2 $\frac{1}{2}$	$\frac{1}{4}, \frac{1}{2}$	$\frac{1}{4}$	—
U3924-XL	UG	C.P.	#6-350	Lever	4 $\frac{7}{8}$	14	20 $\frac{1}{2}$	3	2 $\frac{1}{2}$	$\frac{1}{4}, \frac{1}{2}$	—	—
U4721-O-BL	UG	Blank	#6-350	Lever	5 $\frac{3}{4}$	16	22	4	3 $\frac{1}{2}$	2 $\frac{1}{2}$	1	$\frac{1}{4}$

Notes

- **Hubs:** For proper hub selection, see the hub suffix chart on the accessories page.
- **Fifth Terminal:** For field-installable fifth terminal, order as extra **K3866** for the **U9800**, **U9801**, **U4721**, and **K3865** for the **U3924**.
- **Bypass:** The lever supplies clamping action on meter spades and also operates bypass device.
- **Connectors:** Extruded aluminum connectors are tin plated.

Please consult serving utility for their requirements prior to ordering or installing, as specifications and approvals vary by utility, and may require local electrical inspector approval. All installations must be installed by a licensed electrician and must comply with all national and local codes, laws and regulations. Milbank reserves the right to make changes in specifications and features shown without notice or obligation.



Single Position Lever Bypass

200 Amps | 5 Terminals | Ringless | 600 VAC

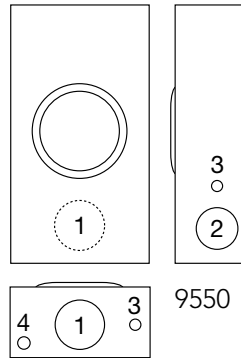

U9550-RRL-QG

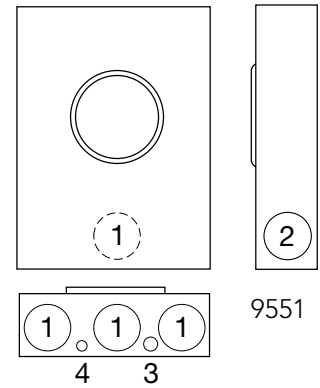

U9551-RXL-QG

200 Amps | 5 Terminals | Ringless | Single Position | 1Ø3W or 3Ø3W

Catalog Number	Service	Hub	Connectors CU/AL	Bypass	Dimensions			Knockouts			
					D"	W"	H"	1	2	3	4
U9550-RRL-QG	OH	H.O.	#6-350	Lever	4 $\frac{7}{8}$	10	18 $\frac{1}{2}$	3	2 $\frac{1}{2}$	$\frac{3}{4}$	$\frac{1}{4}, \frac{1}{2}$
U9551-RXL-QG	OH/UG	C.P.	#6-350	Lever	4 $\frac{7}{8}$	13	19	3	2 $\frac{1}{2}$	$\frac{1}{4}, \frac{1}{2}$	$\frac{1}{4}$

Notes

- **Hubs:** For proper hub selection, see the hub suffix chart on the accessories page.
- **Bypass:** The lever supplies clamping action on meter spades and also operates bypass device.
- **Connectors:** Extruded aluminum connectors are tin plated.



Please consult serving utility for their requirements prior to ordering or installing, as specifications and approvals vary by utility, and may require local electrical inspector approval. All installations must be installed by a licensed electrician and must comply with all national and local codes, laws and regulations. Milbank reserves the right to make changes in specifications and features shown without notice or obligation.

Single Position Lever Bypass

17

200 Amps | 7 Terminals | Ringless | 600 VAC



U9700-RRL-QG-BL

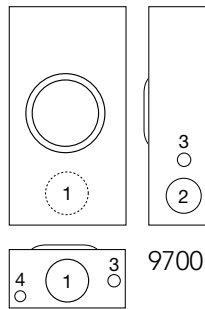

U9701-RXL-QG

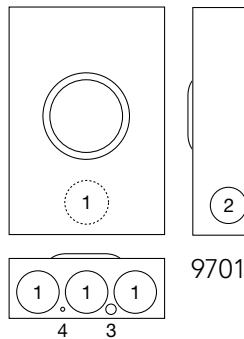

U4910-O-BL

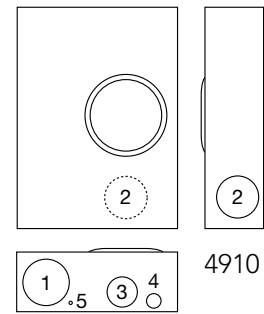

200 Amps | 7 Terminals | Ringless | Single Position | 3Ø4W

Catalog Number	Service	Hub	Connectors CU/AL	Bypass	Dimensions			Knockouts				
					D"	W"	H"	1	2	3	4	4
U9700-RRL-QG-BL	OH	H.O.	#6-350	Lever	4 $\frac{7}{8}$	10	18 $\frac{1}{2}$	3	2 $\frac{1}{2}$	$\frac{3}{4}$	1 $\frac{1}{4}$, 1 $\frac{1}{2}$	—
U9701-RXL-QG	OH/UG	C.P.	#6-350	Lever	4 $\frac{7}{8}$	13	19	3	2 $\frac{1}{2}$	1 $\frac{1}{4}$, 1 $\frac{1}{2}$	1 $\frac{1}{4}$	—
U4910-O-BL	UG	Blank	#6-350	lever	5 $\frac{3}{4}$	16	22	4	3 $\frac{1}{2}$	2 $\frac{1}{2}$	1	1 $\frac{1}{4}$

Notes

- **Hubs:** For proper hub selection, see the hub suffix chart on the accessories page.
- **Bypass:** The lever supplies clamping action on meter spades and also operates bypass device.
- **Connectors:** Extruded aluminum connectors are tin plated.

Please consult serving utility for their requirements prior to ordering or installing, as specifications and approvals vary by utility, and may require local electrical inspector approval. All installations must be installed by a licensed electrician and must comply with all national and local codes, laws and regulations. Milbank reserves the right to make changes in specifications and features shown without notice or obligation.



Single Position Lever Bypass

320 Amps | 4 Terminals | Ringless | 600 VAC



U2448-X

U4778-X-BL

320 Amps | 4 Terminals | Ringless | Single Position | 1Ø3W

Catalog Number	Service	Hub	Connectors CU/AL	Bypass	Dimensions			Knockouts			
					D"	W"	H"	1	2	3	4
U2448-X	OH/UG	C.P.	3/8" x 16 Studs	Lever	6½	17¾	34⅞	4	3	1	¼
U4778-X-BL	OH/UG	C.P.	3/8" x 16 Studs	Lever	6½	17¾	38¾	4	3	1	¼

Notes

- **Hubs:** For proper hub selection, see the hub suffix chart on the accessories page.
- **Bypass:** The lever supplies clamping action on meter spades and also operates bypass device.
- **Connectors:** Units are supplied with 3/8" x 16 hex nuts with Belleville washers. Order **K1540** (single 600 kcmil) or **K1350** (twin 350 kcmil). Order two kits to cover both line and load.
- **Fifth Terminal:** For field-installable fifth terminal, order **K3865** as extra.



Please consult serving utility for their requirements prior to ordering or installing, as specifications and approvals vary by utility, and may require local electrical inspector approval. All installations must be installed by a licensed electrician and must comply with all national and local codes, laws and regulations. Milbank reserves the right to make changes in specifications and features shown without notice or obligation.

Single Position Lever Bypass

19

320 Amps | 5 & 7 Terminals | Ringless | 600 VAC

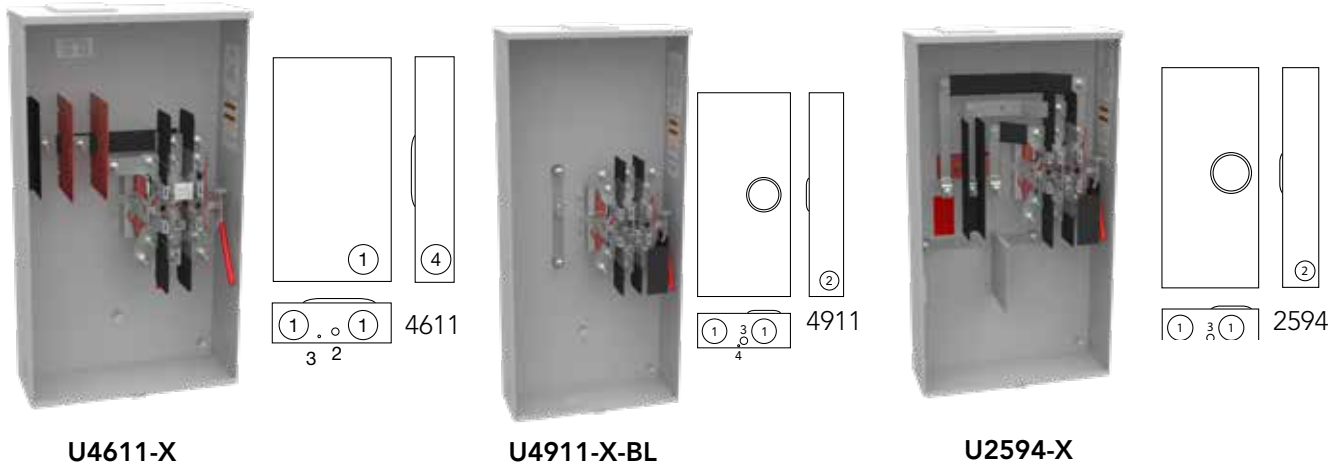

320 Amps | 5 Terminals | Ringless | Single Position | 3Ø3W

Catalog Number	Service	Hub	Connectors CU/AL	Bypass	Dimensions			Knockouts			
					D"	W"	H"	1	2	3	4
U4611-X	OH/UG	C.P.	3/8" x 16 Studs	Lever	6½	17¾	31¼	4	1	¼	3

320 Amps | 7 Terminals | Ringless | Single Position | 3Ø4W

Catalog Number	Service	Hub	Connectors CU/AL	Bypass	Dimensions			Knockouts			
					D"	W"	H"	1	2	3	4
U4911-X-BL	OH/UG	C.P.	3/8" x 16 Studs	Lever	6½	17¾	38¾	4	3	1	¼
U2594-X	OH/UG	C.P.	3/8" x 16 Studs	Lever	6½	19¾	34½	4	3	1	¼

Notes

- **Hubs:** For proper hub selection, see the hub suffix chart on the accessories page.
- **Bypass:** The lever supplies clamping action on meter spades and also operates bypass device.
- **Connectors:** Units are supplied with 3/8" x 16 hex nuts with Belleville washers. Order **K3441** (single 600 kcmil) or **K3442** (twin 350 kcmil). Order two kits to cover both line and load.

Please consult serving utility for their requirements prior to ordering or installing, as specifications and approvals vary by utility, and may require local electrical inspector approval. All installations must be installed by a licensed electrician and must comply with all national and local codes, laws and regulations. Milbank reserves the right to make changes in specifications and features shown without notice or obligation.



100–200 Amps | 4 Terminals | Ringless | 120/240 VAC



U3499-XL-100

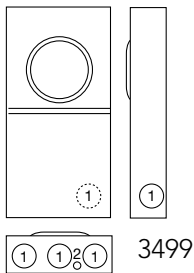

U3990-XL-200

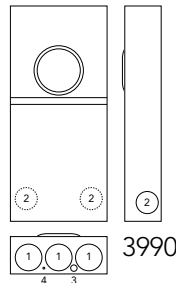

U3798-O-200

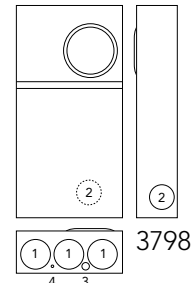

100-200 Amps | 4 Terminals | Ringless | Meter Mains | 1Ø3W

Catalog Number	Amps	Service	Hub	Connectors CU/AL		Bypass	Dimensions			Knockouts			
				Line	Load		D"	W"	H"	1	2	3	4
U3499-XL	100	OH/UG	C.P.	#6-2/0	CB	None	3¾	11	22	2	¼, ½	—	—
U3499-XL-100	100	OH/UG	C.P.	#6-2/0	#6-1/0	None	3¾	11	22	2	¼, ½	—	—
U3990-XL-150	150	OH/UG	C.P.	#2-350	#1/0-300	None	4⅞	13	29	3	2½	¼, ½	¼
U3990-XL-200	200	OH/UG	C.P.	#2-350	#1/0-300	None	4⅞	13	29	3	2½	¼, ½	¼
U3798-O-200	200	UG	Blank	#2-350	#1/0-300	None	4⅞	13	25⅜	3	2½	¼, ½	¼

Notes

- **NEC 2020 Compliant:** All products are NEC 2020 compliant.
- **Hubs:** For proper hub selection, see the hub suffix chart on the accessories page.
- **Circuit Breakers:** The **U3499-XL-100** has a factory-installed 100 Amps breaker. The **U3990-XL-150** and **U3990-XL-200** have factory installed Milbank **UQFBH-(AMP)-X1** breakers. The **U3798-O-200** has a factory-installed **UQFBH-200-X1** breaker.
- **Fifth Terminal:** For field-installable fifth terminal for **U3499**, order **5T8K2**. For **U3990** and **U3798**, order **K5T**.
- **AIC Rating:** Factory installed breakers are rated 22K AIC.



Please consult serving utility for their requirements prior to ordering or installing, as specifications and approvals vary by utility, and may require local electrical inspector approval. All installations must be installed by a licensed electrician and must comply with all national and local codes, laws and regulations. Milbank reserves the right to make changes in specifications and features shown without notice or obligation.

Lever Bypass Meter Mains

21

100–200 Amps | 4 Terminals | Ringless | 120/240 VAC

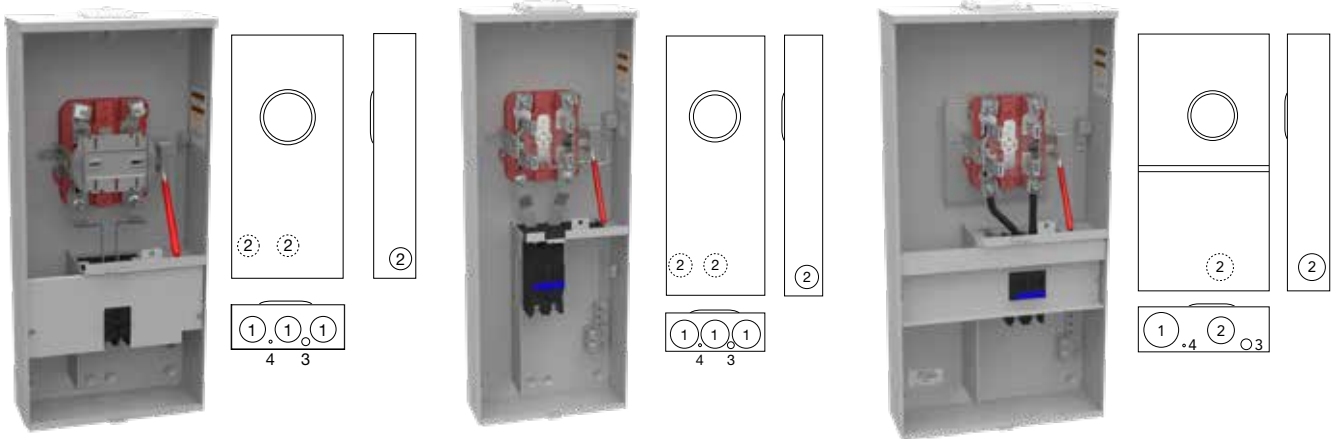

U3741-XL-100-BL

U3791N-RXL-200-BL

U5140-RXL-200-BL

100-200 Amps | 4 Terminals | Ringless | Meter Mains | 1Ø3W

Catalog Number	Amps	Service	Hub	Connectors CU/AL		Bypass	Dimensions			Knockouts			
				Line	Load		D"	W"	H"	1	2	3	4
U3741-XL-100-BL	100	OH/UG	C.P.	#6-1/0	#6-1/0	Lever	4 ⁷ / ₈	13	28	2 ¹ / ₂	2	¼, ½	¼
U3791N-RXL-200-BL	200	OH/UG	C.P.	#6-350	#1/0-300	Lever	4 ⁷ / ₈	13	34	3	2 ¹ / ₂	¼, ½	¼
U5140-RXL-200-BL	200	OH/UG	C.P.	#6-350	#1/0-300	Lever	5 ³ / ₄	17 ³ / ₈	34	4	3	1	¼

Notes

- **NEC 2020 Compliant:** All products are NEC 2020 compliant.
- **Hubs:** For proper hub selection, see the hub suffix chart on the accessories page.
- **Fifth Terminal:** For field-installable fifth terminal, order **K3866**. For a **3W network**, use fifth terminal.
- **Circuit Breakers:** The **U3741** is supplied with a factory-installed 2-pole, 100 Amp 22K plug-in breaker. The **U3791** unit is supplied with a factory installed Milbank **UQFBH-200-X1** 2-pole, 200 Amps bolt-in breaker. The **U5140** a factory installed **UQFBH-200** bolt-in breaker.
- **Bypass:** The lever bypass on the **U3741** operates the sliding bypass only; it is not jaw clamping (medium duty). The lever bypass on the **U3791N** and **U5140** supplies clamping action on the meter spades and also operates the bypass device (heavy duty).
- **Connectors:** Extruded aluminum connectors are tin plated.
- **AIC Rating:** Factory installed breakers are rated 22K AIC.

Please consult serving utility for their requirements prior to ordering or installing, as specifications and approvals vary by utility, and may require local electrical inspector approval. All installations must be installed by a licensed electrician and must comply with all national and local codes, laws and regulations. Milbank reserves the right to make changes in specifications and features shown without notice or obligation.



Meter Mains with Load Center

100–200 Amps | 4 Terminals | Ringless



U5168-XL-200-BL-NE

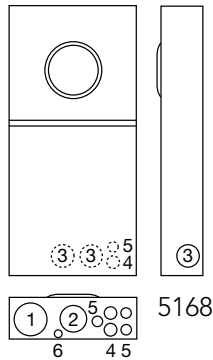

U5898-O-200

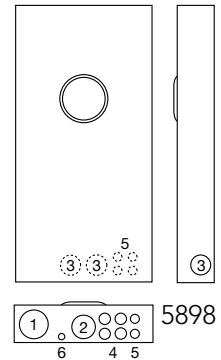

100–200 Amps | 4 Terminals | Ringless | Meter Mains with Load Center | 1Ø3W

Catalog Number	Amps	Service	Hub	Circuits	Connectors CU/ AL – Line	Dimensions			Knockouts					
						D"	W"	H"	1	2	3	4	5	6
U5168-XL-100-BL-NE	100	OH/UG	(2) C.P.	10	#6-350	4½	14⅞	32⅜	3	2½	2	1	½,¾	¼,½
U5168-XL-200-BL-NE	200	OH/UG	(2) C.P.	8	#6-350	4½	14⅞	32⅜	3	2½	2	1	½,¾	¼,½
U5898-O-200	200	UG	Blank	8	#6-350	4½	17	34½	3	2½	2	1	½,¾	¼,½

Notes

- **Fifth Terminal:** For a field-installable fifth terminal for the **U5168** and **U5898**, order **K5T**.
- **Connectors:** Extruded aluminum connectors are tin plated.
- **Breakers:** The **U5168** and **U5898** are rated 22K AIC with **QN2200RH** main breaker installed and have eight branch breaker provisions.



Please consult serving utility for their requirements prior to ordering or installing, as specifications and approvals vary by utility, and may require local electrical inspector approval. All installations must be installed by a licensed electrician and must comply with all national and local codes, laws and regulations. Milbank reserves the right to make changes in specifications and features shown without notice or obligation.

Lever Bypass Meter Mains

23

100–200 Amps | 4 & 7 Terminals | Ringless | 120/240 VAC

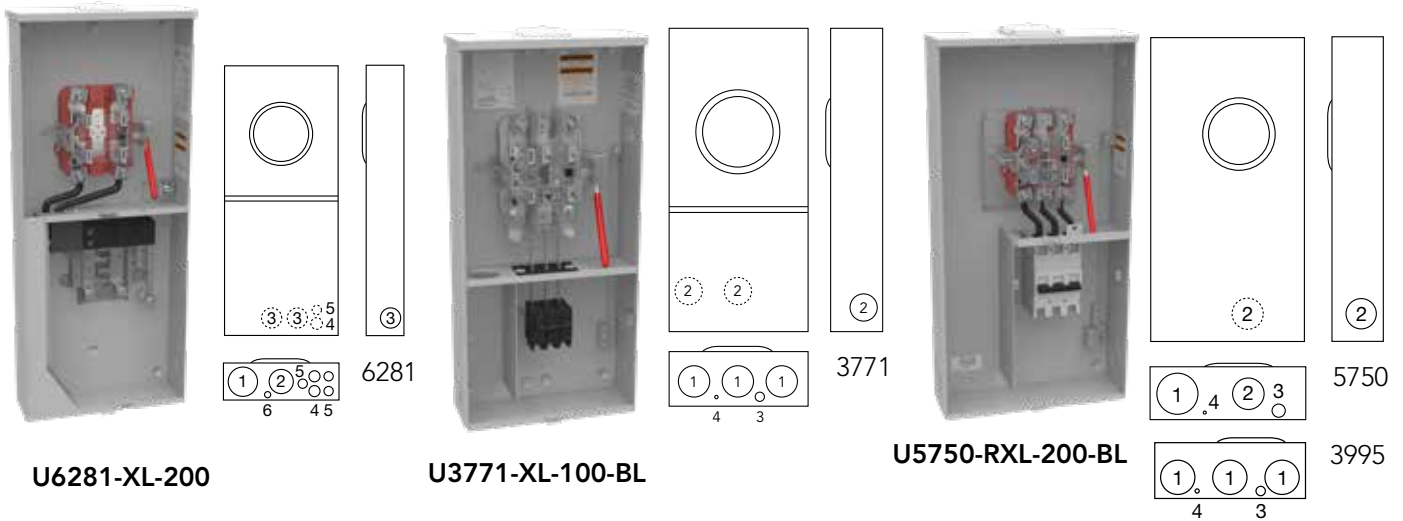

200 Amps | 4 Terminals | Ringless | Meter Main with Load Center | 1Ø3W

Catalog Number	Service	Amps	Hub	Circuits	Connectors CU/AL – Line	Bypass	Dimensions			Knockouts					
							D"	W"	H"	1	2	3	4	5	6
U6281-XL-200	OH/UG	200	C.P.	8	#6-350	Lever	4½	14⅞	34	3	2½	2	1	½,¾	¼,½
U3995-XL-200*	OH/UG	200	C.P.	4	#6-350	Lever	4⅞	16	35	3½	2½	¼,½	¼	—	—

100-200 Amps | 7 Terminals | Ringless | Meter Mains | 3Ø4W

Catalog Number	Service	Amps	Hub	Connectors CU/AL		Bypass	Dimensions			Knockouts			
				Line	Load		D"	W"	H"	1	2	3	4
U3771-XL-100-BL	OH/UG	100	C.P.	#6-2/0	#6-1/0	Lever	4⅞	13	28	2½	2	¼,½	¼
U5750-RXL-200-BL	OH/UG	200	C.P.	#6-350	#1/0-300	Lever	5¾	17⅞	34	4	3	1	¼

Notes

- **NEC 2020 Compliant:** All products are NEC 2020 compliant.
 - **Hubs:** For proper hub selection, see the hub suffix chart on the accessories page.
 - **Fifth Terminal:** For a field-installable fifth terminal for **U6281** and **U3995**, order **K3865**.
 - **Bypass:** The lever on the **U3771** operates the bypass device only; it is not jaw clamping (medium duty). The lever on the **U5750** supplies clamping action on the meter spades and also operates bypass device (heavy duty).
 - **Connectors:** Extruded aluminum connectors are tin plated.
 - **Breakers:** The **U3771** is supplied with a factory-installed 3-pole, 100 Amps plug-in breaker. The **U5750** is supplied with a factory-installed Milbank **UQFB-3200** 3-pole, 200 Amps bolt-on breaker. The **U6281** has is supplied with factory installed Siemens **QN2200RH** breaker and is rated 22K AIC.
- ***U3995-XL-200** has a factory installed **UQFBH-M-200** breaker and provisions for (2) double pole or (4) single pole circuit breakers.

Please consult serving utility for their requirements prior to ordering or installing, as specifications and approvals vary by utility, and may require local electrical inspector approval. All installations must be installed by a licensed electrician and must comply with all national and local codes, laws and regulations. Milbank reserves the right to make changes in specifications and features shown without notice or obligation.



Lever Bypass Meter Mains

320 Amps | 4 Terminals | Ringless

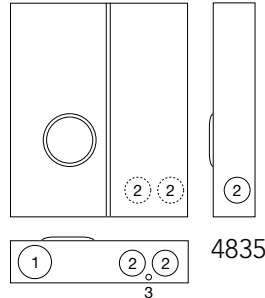

U4835-X-2/200-BL

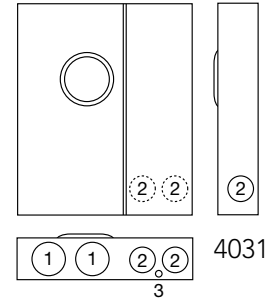

U4031-O-2/200

320 Amps | 4 Terminals | Ringless | Meter Mains | 1Ø

Catalog Number	Service	Hub	Connectors CU/AL		Bypass	Dimensions			Knockouts		
			Line	Load		D"	W"	H"	1	2	3
U4835-X-2/200-BL	OH/UG	C.P.	3/8"-16 Studs	#1/0-300	Lever	5 3/4	25	30	4	3	1/4, 1/2
U4031-O-2/200	UG	Blank	3/8"-16 Studs	#1/0-300	Lever	5 3/4	25	30	4	3	1/4, 1/2

Notes

- **Connectors:** The line wire section is supplied with 3/8"-16 studs with hex head nuts and captive Belleville washers. For single lug connector kits, order **K1539** (350 kcmil) or **K1540** (600 kcmil). For twin lug connector kits, order **K1350** (350 kcmil).
- **Breakers:** The **U4031** and **U4835** are supplied with two bolt-on Milbank **UQFBH-200** breakers at 22K.
- **Bypass:** The lever supplies clamping action on the meter spades and also operates the bypass device.
- **Fifth Terminal:** For field-installable fifth terminal, order catalog number **K3865**.



Please consult serving utility for their requirements prior to ordering or installing, as specifications and approvals vary by utility, and may require local electrical inspector approval. All installations must be installed by a licensed electrician and must comply with all national and local codes, laws and regulations. Milbank reserves the right to make changes in specifications and features shown without notice or obligation.

Lever Bypass Meter Mains

25

320 Amps | 4 Terminals | Ringless | NEC 2020 Compliant



U6584-O-2/200-BL



U6589-O-2/200-BL

320 Amps | 4 Terminals | Ringless | Meter Mains | 1Ø

Catalog Number	Service	Hub	Connectors CU/AL		Bypass	Dimensions			Knockouts		
			Line	Load		D"	W"	H"	1	2	3
U6584-O-2/200-BL	UG	Blank	3/8" -16 Studs	#1/0-300	Lever	5 3/4	33	30	4	3	1/4, 1/2
U6589-X-2/200 BL	OH/UG	C.P.	3/8" -16 Studs	#1/0-300	Lever	5 3/4	33	30	4	3	1/4, 1/2

Notes

- **NEC 2020:** All products are NEC 2020 compliant.
- **Connectors:** The line wire section is supplied with 3/8" -16 studs with hex head nuts and captive Belleville washers. For single lug connector kits, order **K1539** (350 kcmil) or **K1540** (600 kcmil). For twin lug connector kits, order **K1350** (350 kcmil).
- **Breakers:** The **U6584** and **U6589** are supplied with two bolt-on Milbank **UQFBH-200** breakers.
- **Bypass:** The lever supplies clamping action on the meter spades and also operates the bypass device.
- **Fifth Terminal:** For field-installable fifth terminal, order catalog number **K3865**.

Please consult serving utility for their requirements prior to ordering or installing, as specifications and approvals vary by utility, and may require local electrical inspector approval. All installations must be installed by a licensed electrician and must comply with all national and local codes, laws and regulations. Milbank reserves the right to make changes in specifications and features shown without notice or obligation.



26 Lever Bypass Meter Mains w/ 400 Amps Breaker

320 Amps | 4 & 7 Terminals | Ringless | Jaw Clamping



U6227-X-400-K3



U6229-X-400-K7

320 Amps | 4 Terminals | Meter Mains | Lever Bypass | Ringless

Catalog Number	Service	Hub	Connectors CU/AL	Dimensions			Knockouts			
			Line	D"	W"	H"	1	2	3	4
U6227-X-400-K3-BL	OH/UG	C.P.	600 kcmil	6	36¼	34	4	2½	½	¼
U6228-X-400-K3-BL*	OH/UG	C.P.	600 kcmil	6	36¼	34	4	2½	½	¼

320 Amps | 7 Terminals | Meter Mains | Lever Bypass | Ringless

Catalog Number	Service	Hub	Connectors CU/AL	Dimensions			Knockouts			
			Line	D"	W"	H"	1	2	3	4
U6229-X-400-K7-BL	OH/UG	C.P.	600 kcmil	6	36¼	34	4	2½	½	¼
U6230-X-400-K7-BL*	OH/UG	C.P.	600 kcmil	6	36¼	34	4	2½	½	¼

400 Amps | 7 Terminals | Meter Main with Breakers | Ringless | 3Ø4W

Catalog Number	Service	Hub	Connectors CU/AL	Dimensions			Knockouts			
			Line	D"	W"	H"	1	2	3	4
U6115-X-2/200-K7L-BL*	OH/UG	C.P.	#4-600 kcmil or (2) #1/0-250	7	37¼	34	½, ¾	½, ¾	½, ¾	½, ¾

Notes

- **NEC 2020:** All products are NEC 2020 compliant except for the **U6115**.
 - **Short circuit current rating:** 22K AIC at 120/240 VAC or 480 VAC.
 - **Fifth-terminal:** Order **K3865** as a fifth -terminal for **U6227** and **U6228**.
- ***U6228** and **U6230** have side bussing.



Please consult serving utility for their requirements prior to ordering or installing, as specifications and approvals vary by utility, and may require local electrical inspector approval. All installations must be installed by a licensed electrician and must comply with all national and local codes, laws and regulations. Milbank reserves the right to make changes in specifications and features shown without notice or obligation.

Cold Sequence Meter Mains

27

200-400 Amps | 7 Terminals | Use on 480 VAC Services



U5767-X-200-CB-BL

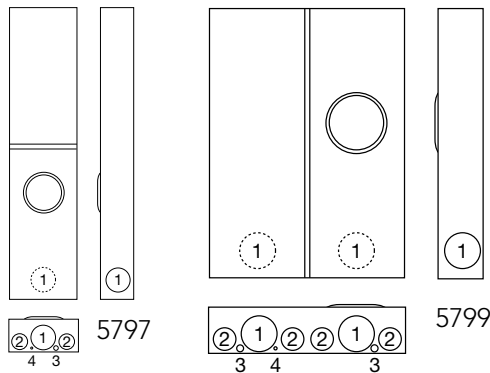
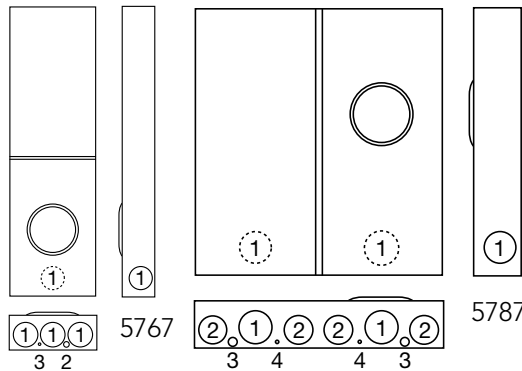

U5799-O-400-CB-BL

200 Amps | Circuit Breaker Disconnect Ahead of Meter Socket | 3Ø4W

Catalog Number	Service	Hub	Connectors CU/AL		Bypass	AIC Rating	Dimensions			Knockouts			
			Line	Load			D"	W"	H"	1	2	3	4
U5767-X-200-CB-BL	OH	C.P.	1/0-350	#6-350	Lever	*See note	4 ²⁷ / ₃₂	13	43	3	¼, ½	¼	—
U5787-O-200-CB	UG	Blank	1/0-350	#6-350	Lever	*See note	4 ²⁷ / ₃₂	26	28	4	½, ¾	1	½, ¾

400 Amps (320 Amps Cont.) | Lever Bypass | Circuit Breaker Disconnect Ahead of Meter Socket | 3Ø4W

Catalog Number	Service	Hub	Connectors CU/AL		AIC Rating	Dimensions			Knockouts			
			Line	Load		D"	W"	H"	1	2	3	4
U5796-X-400-CB-BL	OH	C.P.	(2) 3/0-500	#4-600 or (2) 1/0-250 kcmil	10K	6	13	56	3	¼, ½	¼	—
U5799-O-400-CB-BL	UG	Blank	(2) 3/0-500	#4-600 or (2) 1/0-250 kcmil	10K	6	26	36	4 ½	2 ¼	2 ⅞	

Notes

*AIC ratings: Circuit breaker rated 600 VAV at 22K AIC, 480 VAC at 35K AIC, and 240 VAC at 65K AIC.

Please consult serving utility for their requirements prior to ordering or installing, as specifications and approvals vary by utility, and may require local electrical inspector approval. All installations must be installed by a licensed electrician and must comply with all national and local codes, laws and regulations. Milbank reserves the right to make changes in specifications and features shown without notice or obligation.



Vertical Multi-Position Sockets

100 Amps | 4 Terminals | Ringless | 300 VAC



U2692-XL

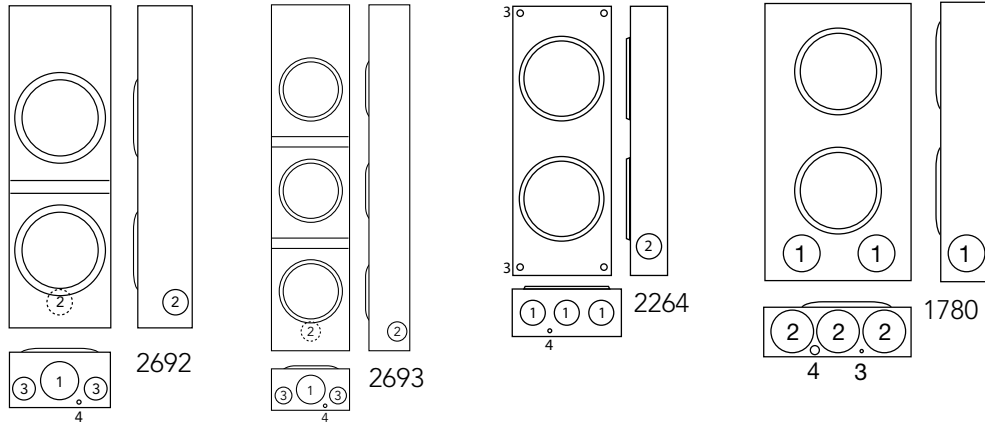

100 Amps | 4 Terminals | Multi-Position | Ringless

Catalog Number	Positions	Service	Hub	Connectors CU/AL		Bypass	Dimensions			Knockouts			
				Line	Load		D"	W"	H"	1	2	3	4
U2692-XL	2	OH/UG	C.P.	#2-350	#6-2/0	None	4 $\frac{1}{8}$	8	25 $\frac{1}{4}$	2 $\frac{1}{2}$	1 $\frac{1}{2}$	1 $\frac{1}{4}$	$\frac{1}{4}$
U2693-XL	3	OH/UG	C.P.	#2-350	#6-2/0	None	4 $\frac{1}{8}$	8	35 $\frac{23}{32}$	2 $\frac{1}{2}$	1 $\frac{1}{2}$	1 $\frac{1}{4}$	$\frac{1}{4}$
U2264-XL*	2	OH/UG	C.P.	#2-350	#6-2/0	*	4 $\frac{27}{32}$	11	30	2 $\frac{1}{2}$	2 $\frac{1}{2}$	—	$\frac{1}{4}$

200 Amps Upper Socket & 100 Amps Lower Socket | 4 Terminals | Multi-Position | Ring Type

Catalog Number	Positions	Service	Hub	Connectors CU/AL		Bypass	Dimensions			Knockouts			
				Line	Load		D"	W"	H"	1	2	3	4
U1780-O	2	UG	Blank	#2-350	#6-2/0	None	4 $\frac{1}{8}$	11	26	2 $\frac{1}{2}$	2 $\frac{1}{2}$	$\frac{1}{4}$	$\frac{1}{4}$ $\frac{1}{2}$

Notes

- **Hubs:** For proper hub selection, see the hub suffix chart on the accessories page.
- **Fifth Terminal:** For a field-installable fifth terminal, order catalog number **5T8K2**.
- **Connectors:** Extruded aluminum connectors are tin plated.
- **Bussing:** $\frac{1}{4}$ x 1" aluminum bussing is supplied.

*Upper meter socket has a medium duty lever bypass and upper socket is 200 Amps, and the lower socket is 100 Amps no bypass.



Please consult serving utility for their requirements prior to ordering or installing, as specifications and approvals vary by utility, and may require local electrical inspector approval. All installations must be installed by a licensed electrician and must comply with all national and local codes, laws and regulations. Milbank reserves the right to make changes in specifications and features shown without notice or obligation.

Multi-Position Sockets

100 Amps per Position | 4 Terminals | Ringless | 300 VAC



U7363-DL

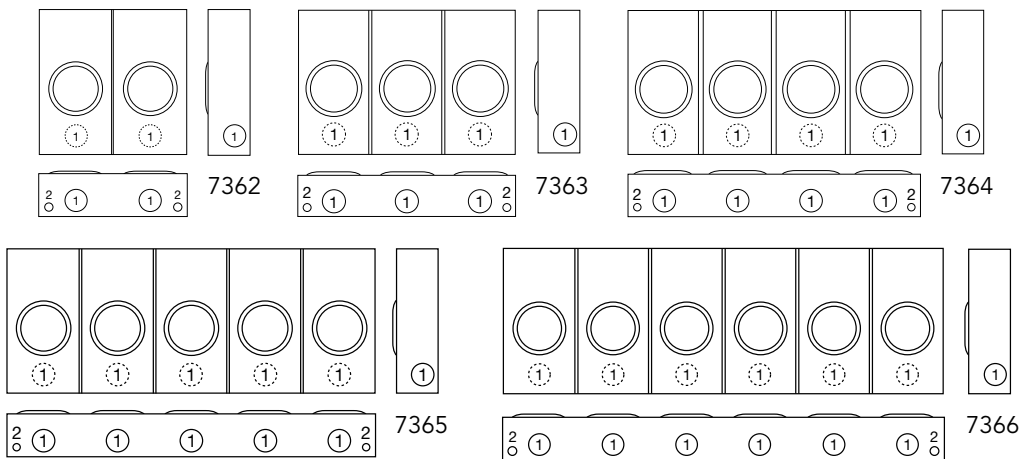

100 Amps per Position | 4 Terminals | Multi-Position | Ringless

Catalog Number	Positions	Service	Hub	Connectors CU/AL			Bypass	Dimensions			Knockouts	
				Line	Load			D"	W"	H"	1	2
U7362-DL	2	OH	2"	#6-350	#6-2/0	None	4½	16 ⁵ / ₁₆	16	2	¼, ½	
U7363-DL	3	OH	2"	#6-350	#6-2/0	None	4½	24½	16	2	¼, ½	
U7364-DL	4	OH	2"	#6-350	#6-2/0	None	4½	32 ¹ / ₁₆	16	2	¼, ½	
U7365-DL	5	OH	2"	#6-350	#6-2/0	None	4½	40 ⁷ / ₈	16	2	¼, ½	
U7366-DL	6	OH	2"	#6-350	#6-2/0	None	4½	49 ¹ / ₁₆	16	2	¼, ½	

Notes

- **Hubs:** For proper hub selection, refer to the hub suffix chart on the accessories page. Hub opening is supplied at each end. Extra opening is closed with a closing plate.
- **Fifth Terminal:** For field-installable fifth terminal, order catalog number K1815 for each meter position.
- **Connectors:** Extruded aluminum connectors are tin plated.
- **Bussing:** Bussing is 5/16" x 1" aluminum.

Please consult serving utility for their requirements prior to ordering or installing, as specifications and approvals vary by utility, and may require local electrical inspector approval. All installations must be installed by a licensed electrician and must comply with all national and local codes, laws and regulations. Milbank reserves the right to make changes in specifications and features shown without notice or obligation.



100-200 Amps | 4 Terminals | Ringless | 300 VAC

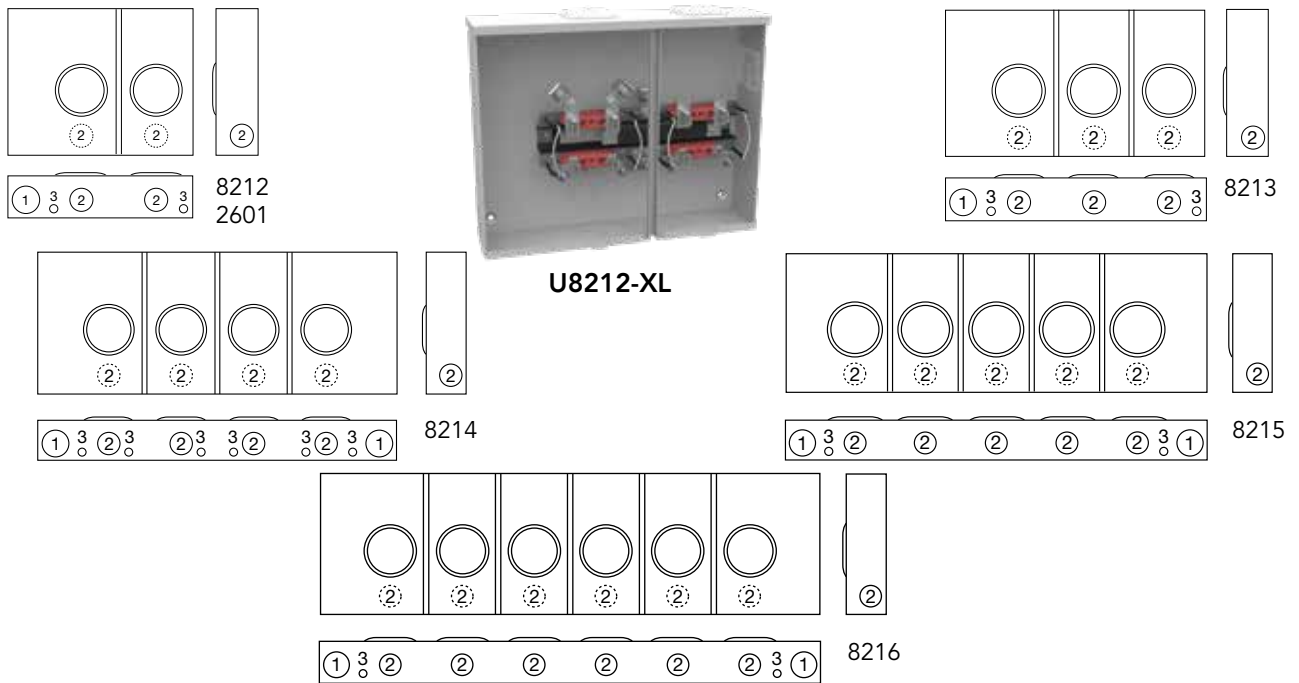

100 Amps per Position | 4 Terminals | Multi-Position | End Wireway | Ringless

Catalog Number	Positions	Service	Hub	Connectors CU/AL		Dimensions			Knockouts		
				Line	Load	D"	W"	H"	1	2	3
U8212-XL	2	OH/UG	C.P.	#6-350	#6-2/0	4½	20 ⁵ / ₁₆	16	2½	2	¼, ½
U8213-XL	3	OH/UG	C.P.	#6-350	#6-2/0	4½	28½	16	2½	2	¼, ½
U8214-XL	4	OH/UG	C.P.	#6-350	#6-2/0	4½	40 ¹¹ / ₁₆	16	2½	2	¼, ½
U8215-XL	5	OH/UG	C.P.	#6-350	#6-2/0	4½	48 ⁷ / ₈	16	2½	2	¼, ½
U8216-XL	6	OH/UG	C.P.	#6-350	#6-2/0	4½	57 ¹ / ₁₆	16	2½	2	¼, ½

200 Left /100 Right Amps per Position | 4 Terminals | Multi-Position | End Wireway | Ringless

Catalog Number	Positions	Service	Hub	Connectors CU/AL		Dimensions			Knockouts		
				Line	Load	D"	W"	H"	1	2	3
U2601-XL	2	OH/UG	C.P.	#2-350	Left - #2-350 Right - #6-2/0	4½	20 ⁵ / ₁₆	16	2½	2	¼, ½

Notes

- **Hubs:** For proper hub selection, refer to the hub suffix chart on the accessories page. Hub opening is supplied at each end. Extra opening is closed with a closing plate.
- **Fifth Terminal:** For field-installable fifth terminal, order catalog number K1815 for each meter position.
- **Connectors:** Extruded aluminum connectors are tin plated.
- **Bussing:** Bussing is 5/16" x 1" aluminum.



Please consult serving utility for their requirements prior to ordering or installing, as specifications and approvals vary by utility, and may require local electrical inspector approval. All installations must be installed by a licensed electrician and must comply with all national and local codes, laws and regulations. Milbank reserves the right to make changes in specifications and features shown without notice or obligation.

Multi-Position Sockets

31

200 Amps | 4 Terminals | Ringless | 300 VAC



U1252-X-K1

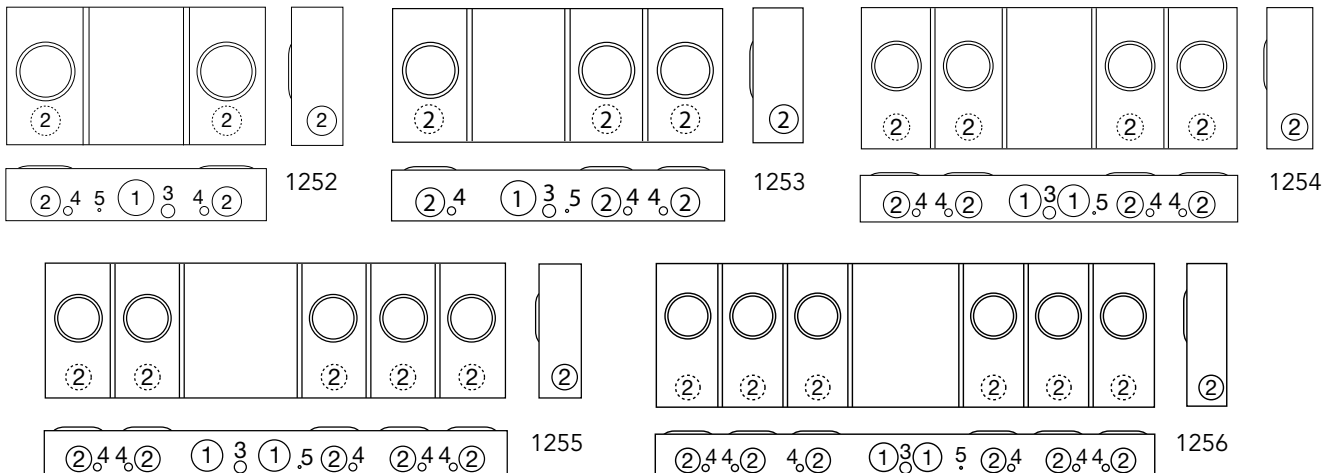

200 Amps per Position | 4 Terminals | Multi-Position | Ringless | 1Ø3W

Catalog Number	Positions	Service	Hub	Connectors CU/AL		Bypass	Dimensions			Knockouts				
				Line	Load		D"	W"	H"	1	2	3	4	5
U1252-X-K1	2	OH/UG	C.P.	#6-350	#6-350	None	5½	26½	14	3	2½	1	½	¼
U1253-X-K3	3	OH/UG	C.P.	#4-600	#6-350	None	5½	34¾	14	3	2½	1	½	¼
U1254-X-K3	4	OH/UG	C.P.	#4-600	#6-350	None	5½	42⅞	16	3	2½	1	½	¼
U1255-X-K4	5	OH/UG	C.P.	(2) #2-600	#6-350	None	5½	54⅞	16	3	2½	1	½	¼
U1256-X-K4	6	OH/UG	C.P.	(2) #2-600	#6-350	None	5½	63¼	18	3	2½	1	½	¼

Notes

- **Hubs:** For proper hub selection, see the hub suffix chart on the accessories page.
- **Fifth Terminal:** For a field-installable fifth terminal, order catalog number **K5T**.
- **Connectors:** Extruded aluminum connectors are tin plated.
- **Bussing:** 5/16" x 1" aluminum bussing is supplied in the **U1252**. 5/16" x 1" aluminum bussing is supplied in the **U1253–U1256**.
- **Overhead Service:** Extension kits for 4, 5 & 6 gang sockets available. Consult factory.
- **U1252-X-K1:** 400 circuit bus rating.

Please consult serving utility for their requirements prior to ordering or installing, as specifications and approvals vary by utility, and may require local electrical inspector approval. All installations must be installed by a licensed electrician and must comply with all national and local codes, laws and regulations. Milbank reserves the right to make changes in specifications and features shown without notice or obligation.



32

Multi-Position Sockets

125 Amps per Position | 4 Terminals | Ringless | 300 VAC

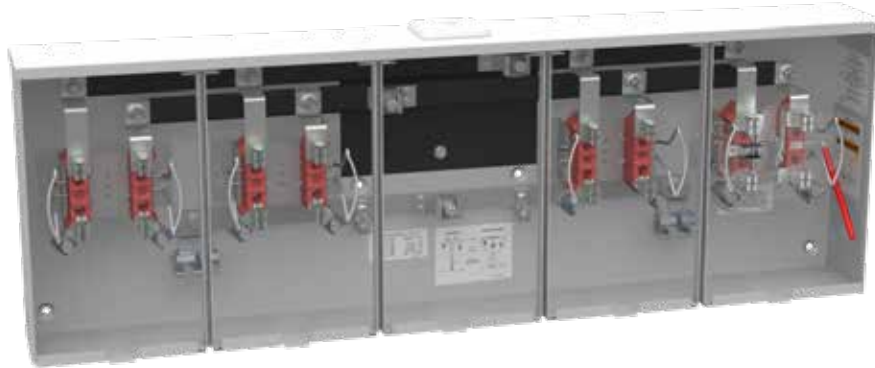

U3764-XL

NOTE

Each unit is supplied with a 125 Amps non jaw clamping lever bypass block assembly in the far right meter position only. All remaining positions are 125 Amps with no bypass.

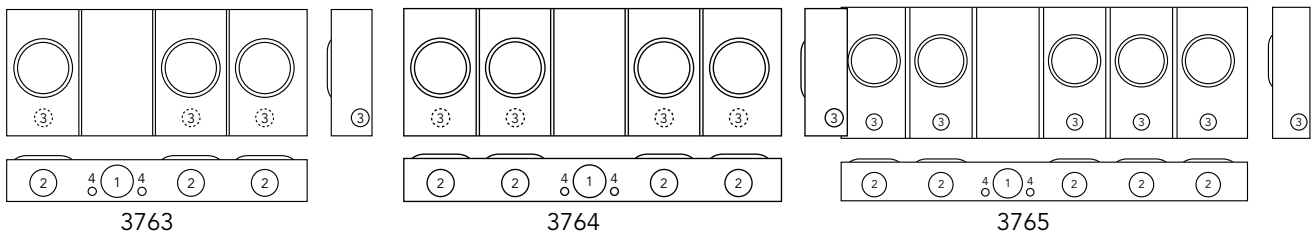

125 Amps | 5 Terminals | Multi-Position | Ringless

Catalog Number	Positions	Service	Hub	Connectors CU/AL		Bypass	Dimensions			Knockouts			
				Line	Load		D"	W"	H"	1	2	3	4
U3763-XL	3	OH/UG	C.P.	#2-350	#6-2/0	See note above	4½	33⅞	14	3	2½	1½	¼, ½
U3764-XL	4	OH/UG	C.P.	#2-350	#6-2/0	See note above	4½	41⅞	14	3	2½	1½	¼, ½
U3765-XL	5	OH/UG	C.P.	#2-350	#6-2/0	See note above	4½	49⅜	16	3	2½	1½	¼, ½

Notes

- **Hubs:** For proper hub selection, see the hub suffix chart on the accessories page.
- **Fifth Terminal:** For a field-installable fifth terminal, order catalog number 5T8K2 for tenant positions, and order K3356 for the far right house power lever bypass socket.
- **Connectors:** Extruded aluminum connectors are tin plated.
- **Bussing:** ¼" x 1" aluminum bussing is supplied.



Please consult serving utility for their requirements prior to ordering or installing, as specifications and approvals vary by utility, and may require local electrical inspector approval. All installations must be installed by a licensed electrician and must comply with all national and local codes, laws and regulations. Milbank reserves the right to make changes in specifications and features shown without notice or obligation.

Vertical Lever Bypass Multi-Position Sockets 33

100 Amps per Position | 5 Terminals | Ringless | 300 VAC



U5112-X-5T9-BL

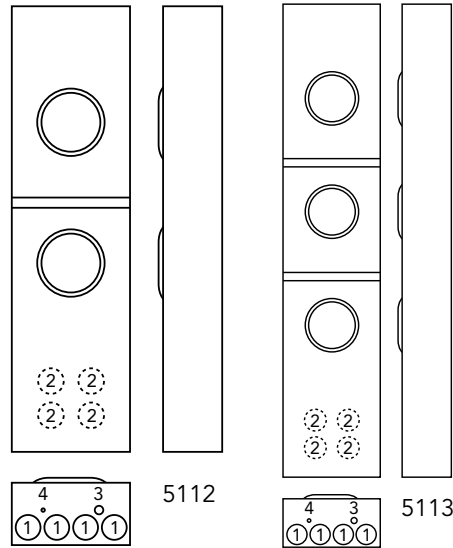

100 Amps per Position | 5 Terminals | Multi-Position | Ringless

Catalog Number	Positions	Service	Hub	Connectors CU/AL		Bypass	Dimensions			Knockouts			
				Line	Load		D"	W"	H"	1	2	3	4
U5112-X-5T9-BL	2	OH	C.P.	#6-350	#6-2/0	Lever	6	12	44½	2½	2	¼, ½	¼
U5113-X-5T9-BL	3	OH	C.P.	#6-350	#6-2/0	Lever	6	12	58½	2½	2	1¼	¼

Notes

- **Hubs:** For proper hub selection, see the hub suffix chart on the accessories page.
- **Connectors:** Extruded aluminum connectors are tin plated.
- **Bussing:** ¼ x 1" aluminum bussing is supplied.

Please consult serving utility for their requirements prior to ordering or installing, as specifications and approvals vary by utility, and may require local electrical inspector approval. All installations must be installed by a licensed electrician and must comply with all national and local codes, laws and regulations. Milbank reserves the right to make changes in specifications and features shown without notice or obligation.



34

Lever Bypass Multi-Position Sockets

100 Amps per Position | 5 Terminals | Ringless | 600 VAC

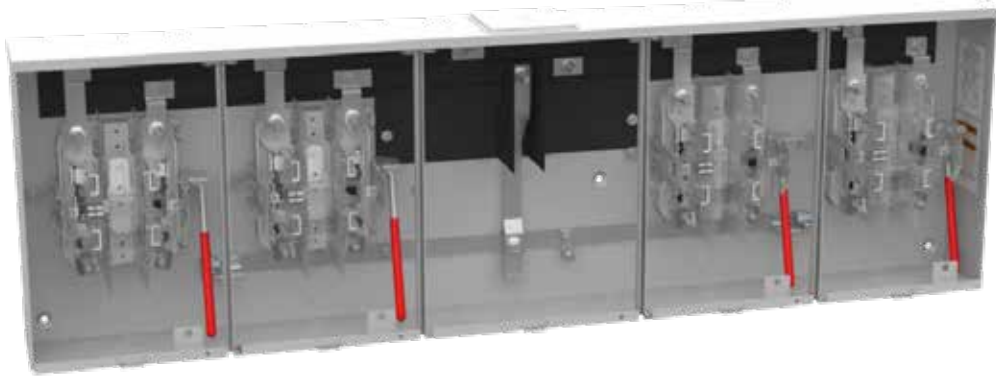

U2754-X-5T9

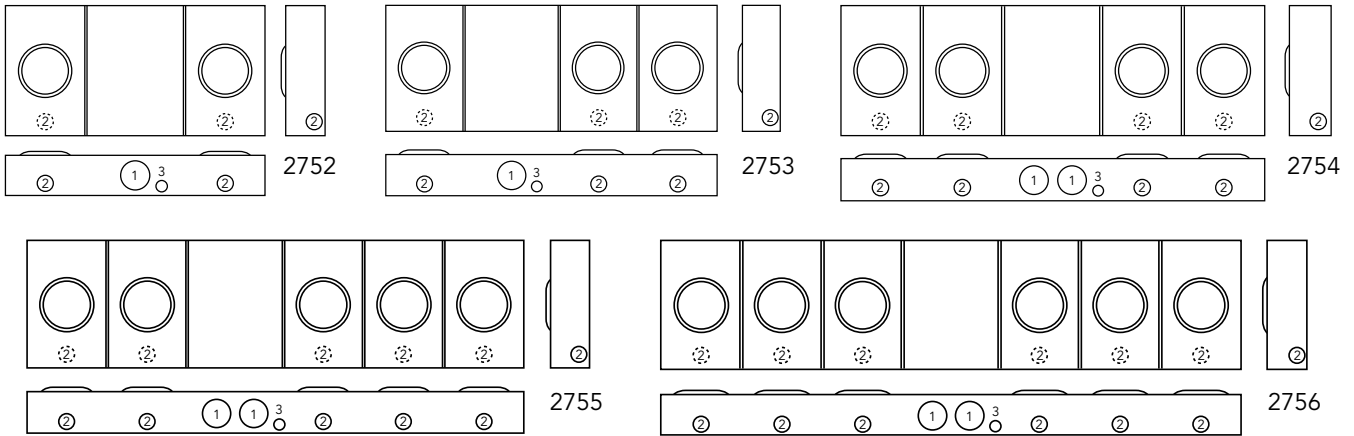

100 Amps per Position | 5 Terminals | Multi-Position | Ringless

Catalog Number	Positions	Service	Hub	Connectors CU/AL		Bypass	Dimensions			Knockouts		
				Line	Load		D"	W"	H"	1	2	3
U2752-X-5T9	2	OH/UG	C.P.	3/8 x 16 Studs	#6-2/0	Lever	4 7/8	32 1/8	16	3	1 1/2	1
U2753-X-5T9	3	OH/UG	C.P.	3/8 x 16 Studs	#6-2/0	Lever	4 7/8	42 1/4	16	3	1 1/2	1
U2754-X-5T9	4	OH/UG	C.P.	3/8 x 16 Studs	#6-2/0	Lever	4 7/8	52 1/4	16	3	1 1/2	1
U2755-X-5T9	5	OH/UG	C.P.	3/8 x 16 Studs	#6-2/0	Lever	4 7/8	62 3/8	16	3	1 1/2	1
U2756-X-5T9	6	OH/UG	C.P.	3/8 x 16 Studs	#6-2/0	Lever	4 7/8	72 3/8	16	3	1 1/2	1

Notes

- **Fifth Terminal:** The fifth terminal is factory installed in the 9 o'clock position. May change in field to the 6 o'clock position.
- **Connectors:** Aluminum extruded load side connectors are tin plated. For line side single lug connector kits, order **K1539** (350 kcmil) or **K1540** (600 kcmil) as extra. For twin lug connectors, order **K1350** (350 kcmil) or **K1541** (600 kcmil) as extra.
- **Bussing:** 1/4 x 1" aluminum bussing is supplied.
- **Bypass:** The lever operates bypass only; it is not jaw clamping (medium duty).



Please consult serving utility for their requirements prior to ordering or installing, as specifications and approvals vary by utility, and may require local electrical inspector approval. All installations must be installed by a licensed electrician and must comply with all national and local codes, laws and regulations. Milbank reserves the right to make changes in specifications and features shown without notice or obligation.

Lever Bypass Multi-Position Sockets

35

200 Amps per Position | 5 Terminals | Ringless | 600 VAC

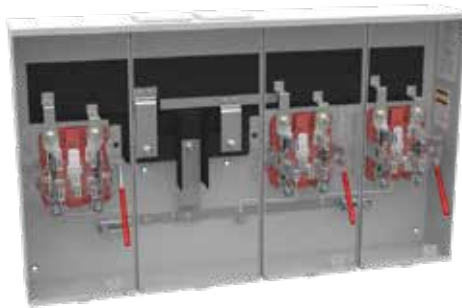

U2873-Xt-5t9

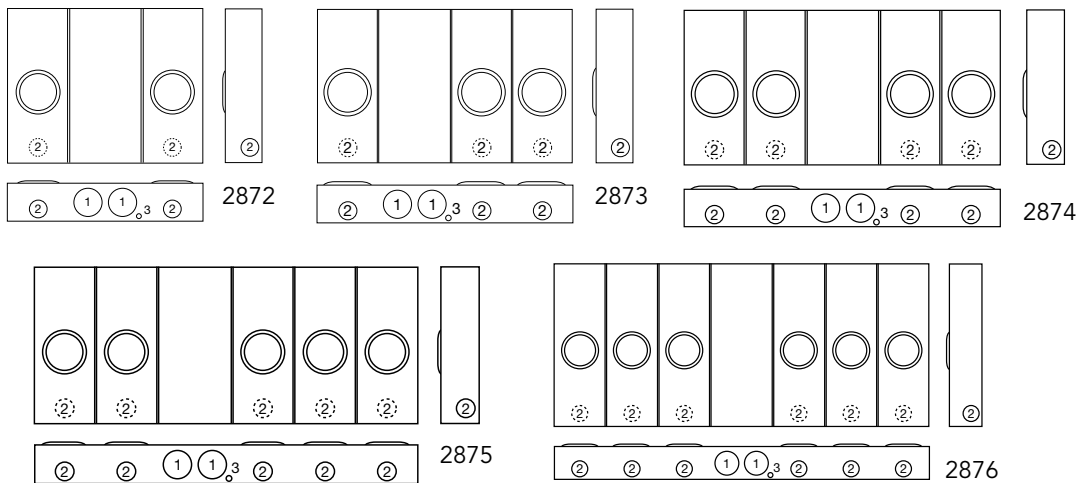

200 Amps per Position | 5 Terminals | Multi-Position | Ringless | 1Ø3W

Catalog Number	Positions	Service	Hub	Connectors CU/AL		Bypass	Dimensions			Knockouts		
				Line	Load		D"	W"	H"	1	2	3
U2872-Xt-5t9	2	OH/UG	(2) C.P.	3/8" x 16 Studs	#6-350	Lever	6	32 3/8	25 1/4	4	2 1/2	1 1/4, 1 1/2
U2873-Xt-5t9	3	OH/UG	(2) C.P.	3/8" x 16 Studs	#6-350	Lever	6	42 3/16	25 1/4	4	2 1/2	1 1/4, 1 1/2
U2874-Xt-5t9	4	OH/UG	(2) C.P.	3/8" x 16 Studs	#6-350	Lever	6	52 1/4	25 1/4	4	2 1/2	1 1/4, 1 1/2
U2875-Xt-5t9	5	OH/UG	(2) C.P.	3/8" x 16 Studs	#6-350	Lever	6	62 3/16	25 1/4	4	2 1/2	1 1/4, 1 1/2
U2876-Xt-5t9	6	OH/UG	(2) C.P.	3/8" x 16 Studs	#6-350	Lever	6	72 3/8	31 1/4	4	2 1/2	1 1/4, 1 1/2

Notes

- **Hubs:** Units supplied with two closing plates. To order as extra, refer to the hub suffix chart in the accessories section.
- **Connectors:** Units supplied with 3/8"-16 hex head nuts with Belleville washers on line side. Order connector kits **K1539** (350 kcmil), **K1540** (600 kcmil), **K1350** (twin 350 kcmil) or **K1541** (twin 600 kcmil).
- **Bypass:** Lever supplies clamping action on meter spades and also operates bypass device.
- **Fifth Terminal:** The fifth terminal is factory installed in the 9 o'clock position; may be changed in field to the 6 o'clock position.
- **Bussing:** 3/8" x 1" aluminum bussing is supplied.

Please consult serving utility for their requirements prior to ordering or installing, as specifications and approvals vary by utility, and may require local electrical inspector approval. All installations must be installed by a licensed electrician and must comply with all national and local codes, laws and regulations. Milbank reserves the right to make changes in specifications and features shown without notice or obligation.



36

Lever Bypass Multi-Position Sockets

200 Amps per Position | 7 Terminals | Ringless | 600 VAC



U2732-XT

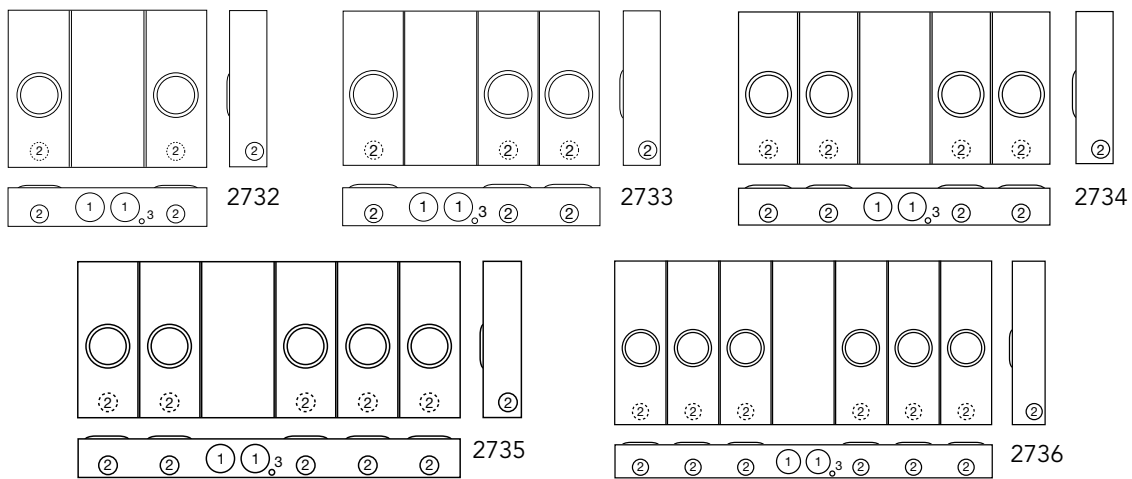

200 Amps per Position | 7 Terminals | Multi-Position | Ringless | 3Ø4W

Catalog Number	Positions	Service	Hub	Connectors CU/AL		Dimensions			Knockouts		
				Line	Load	D"	W"	H"	1	2	3
U2732-XT	2	OH/UG	(2) C.P.	3/8" x 16 Studs	#6-350	6	32 1/8	25 1/4	4	2 1/2	1/4, 1/2
U2733-XT	3	OH/UG	(2) C.P.	3/8" x 16 Studs	#6-350	6	42 3/16	25 1/4	4	2 1/2	1/4, 1/2
U2734-XT	4	OH/UG	(2) C.P.	3/8" x 16 Studs	#6-350	6	52 1/4	25 1/4	4	2 1/2	1/4, 1/2
U2735-XT	5	OH/UG	(2) C.P.	3/8" x 16 Studs	#6-350	6	62 5/16	25 1/4	4	2 1/2	1/4, 1/2
U2736-XT	6	OH/UG	(2) C.P.	3/8" x 16 Studs	#6-350	6	72 3/8	31 1/4	4	2 1/2	1/4, 1/2

Notes

- **Hubs:** Units supplied with two closing plates. To order as extra, refer to the hub suffix chart in the accessories section.
- **Connectors:** For line side connector kits, order as extra **K3082** (350 kcmil), **K3441** (600 kcmil), **K3442** (twin 350 kcmil), or **K3083** (twin 600 kcmil). Line connectors can be reversed to change from overhead to underground service.
- **Bypass:** Lever supplies clamping action on meter spades and also operates bypass device.
- **Bussing:** 3/8" x 1" aluminum bussing is supplied.



Please consult serving utility for their requirements prior to ordering or installing, as specifications and approvals vary by utility, and may require local electrical inspector approval. All installations must be installed by a licensed electrician and must comply with all national and local codes, laws and regulations. Milbank reserves the right to make changes in specifications and features shown without notice or obligation.

Multi-Position Meter Mains

37

125 Amps per Position | 4 Terminals | Ringless | 120/240 VAC



U6123-X-BL

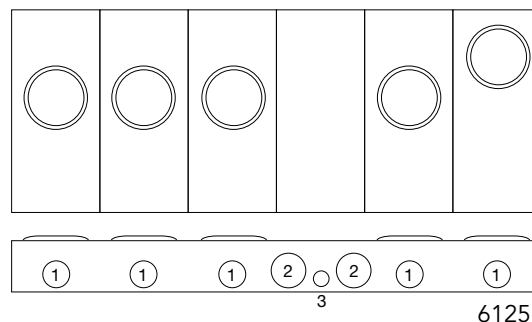
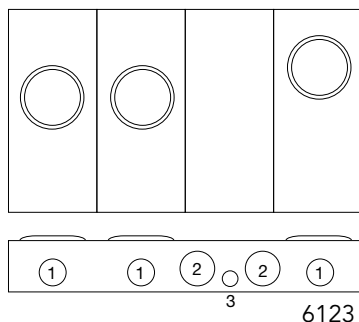

NOTE
Each unit is supplied with a 125 Amps jaw clamping lever bypass block assembly in the far right meter position only. All remaining positions are 125 Amps with no bypass.

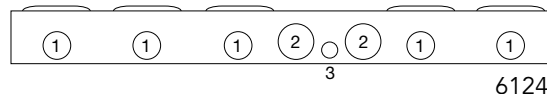
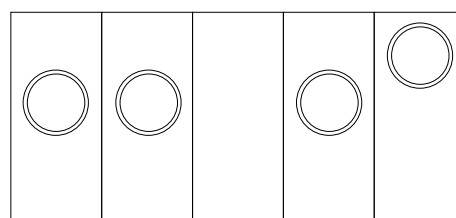

125 Amps per Position | Multi-Position Meter Mains | Ringless

Catalog Number	Service	Positions	Main Bus Rating	Line Connector Size		Dimensions			Knockouts		
				Line	Load	D"	W"	H"	1	2	3
U6123-X-BL	OH/UG	3	300 Amps	3/8" x 16 Studs*	C.B.	5 ³¹ / ₃₂	36 ¹ / ₂	30 ¹ / ₂	2 ¹ / ₂	3	1
U6124-X-BL	OH/UG	4	400 Amps	3/8" x 16 Studs*	C.B.	5 ³¹ / ₃₂	44 ¹³ / ₁₆	30 ¹ / ₂	2 ¹ / ₂	3	1
U6125-X-BL	OH/UG	5	500 Amps	3/8" x 16 Studs*	C.B.	5 ³¹ / ₃₂	53 ¹ / ₁₆	30 ¹ / ₂	2 ¹ / ₂	3	1

Notes

- **NEC 2020 Compliant:** All products are NEC 2020 compliant.
- **AIC Rating:** All models are rated 22K AIC when used with approved breakers rated at 22K.
- **Hubs:** Units supplied with one closing plate. To order as extra, see hub suffix chart on accessories page.
- **Fifth Terminal:** For a field-installable fifth terminal, order catalog number K5T for tenant positions, and order K3865 for the far right house power lever bypass socket.

Manufacturer	Cutler-Hammer	Siemens	GE (50 Amps Max)	Square D
125 Amps or Less	BR, HQP, QPGF	QP, QPH (22K)	THQL	Homeline

Please consult serving utility for their requirements prior to ordering or installing, as specifications and approvals vary by utility, and may require local electrical inspector approval. All installations must be installed by a licensed electrician and must comply with all national and local codes, laws and regulations. Milbank reserves the right to make changes in specifications and features shown without notice or obligation.



Multi-Position Meter Mains

125 & 200 Amps | 4 Terminals | Ringless | 120/240 VAC



U2854-X



U2866-X

125 Amps per Position | Multi-Position Sockets | Ringless

Catalog Number	Amps Per Position	Positions	Service	Main Bus Rating	Line Connector Size	Dimensions		
						D"	W"	H"
U2852-X	125	2	OH/UG	200 Amps	3/8" x 16 Studs*	5 ¹³ / ₁₆	18	25
U2853-X	125	3	OH/UG	200 Amps	3/8" x 16 Studs*	5 ¹³ / ₁₆	18	37
U2854-X	125	4	OH/UG	400 Amps	3/8" x 16 Studs*	4 ⁷ / ₈	31	25
U2855-X	125	5	OH/UG	400 Amps	3/8" x 16 Studs*	4 ⁷ / ₈	31	37
U2856-X	125	6	OH/UG	400 Amps	3/8" x 16 Studs*	4 ⁷ / ₈	31	37

200 Amps per Position | Multi-Position Sockets | Ringless

Catalog Number	Amps Per Position	Positions	Service	Main Bus Rating	Line Connector Size	Dimensions		
						D"	W"	H"
U2288-RXL	200	1	OH/UG	200 Amps	#6-350 kcmil	4 ²⁷ / ₃₂	13	21
U2862-X	200	2	OH/UG	250 Amps	3/8" x 16 Studs*	5 ¹³ / ₁₆	21	29
U2863-X	200	3	OH/UG	300 Amps	3/8" x 16 Studs*	5 ¹³ / ₁₆	21	41
U2864-X	200	4	OH/UG	400 Amps	3/8" x 16 Studs*	4 ⁷ / ₈	36	29
U2865-X	200	5	OH/UG	600 Amps	3/8" x 16 Studs*	4 ⁷ / ₈	36	41
U2866-X	200	6	OH/UG	600 Amps	3/8" x 16 Studs*	4 ⁷ / ₈	36	41

Connector Kits*

Size	Suffix	Kit Number	Compatible With	Wire Range
Single	-K1	K1539	U2852-56, U2862-66	#6-350
	-K3	K1540	U2854-56, U2864-66	#4-600
Twin	-K2	K1350	U2854-56, U2863-66	#6-350
	-K4	K1541	U2864-66	#2-600

Breaker Chart

Manufacturer	150–200 Amps	125 Amps or Less
Cutler-Hammer	BJ, WBJ	Quicklag P, BR, HQP
Siemens	QNR	QP
Murray	MD	MP
GE		Q Line
Square D	—	Homeline

Notes

- **Connectors:** For line wire connector kits, order separately.
- **Fifth Terminal:** For field mounted fifth terminal, order catalog number **K2381**. Order one per meter position.
- **Breakers:** Units have provision for one 2-pole main per meter position. Breakers not included.
- **Short Circuit Current Rating:** 10K AIC. However, this rating is limited to the lowest interrupting capacity of any circuit breaker installed. Watt-hour meter not included in short circuit current rating.



Please consult serving utility for their requirements prior to ordering or installing, as specifications and approvals vary by utility, and may require local electrical inspector approval. All installations must be installed by a licensed electrician and must comply with all national and local codes, laws and regulations. Milbank reserves the right to make changes in specifications and features shown without notice or obligation.

Multi-Position Meter Mains

Knockout Information

Catalog Number	Knockouts			
	1	2	3	4
U2288-RXL	2½	4	¼, ½	3
U2852-X	3	1¼	¼, ½	—
U2853-X	3	1¼	¼, ½	—
U2854-X	3	1¼	¼, ½	—
U2855-X	3	1¼	¼, ½	—
U2856-X	3	1¼	¼, ½	—
U2862-X	3	2	¼, ½	—
U2863-X	3	2	¼, ½	—
U2864-X	3	2	¼, ½	—
U2865-X	3	2	¼, ½	—
U2866-X	3	2	¼, ½	—

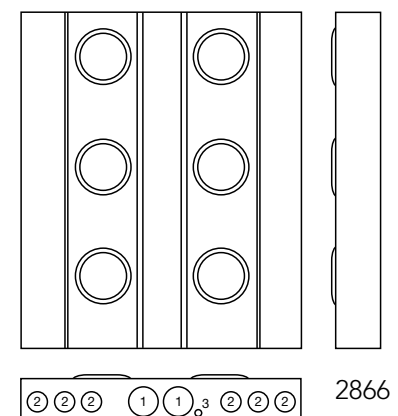
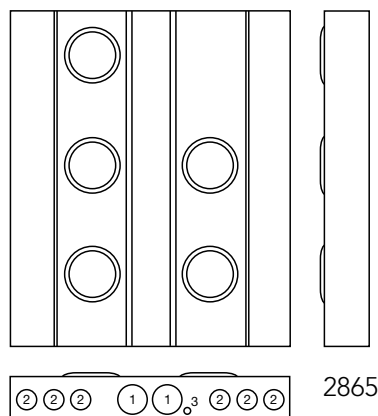
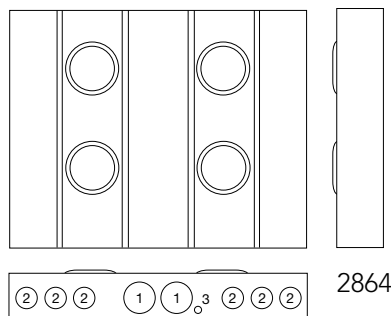
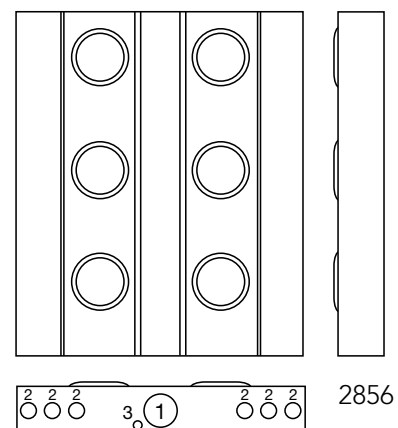
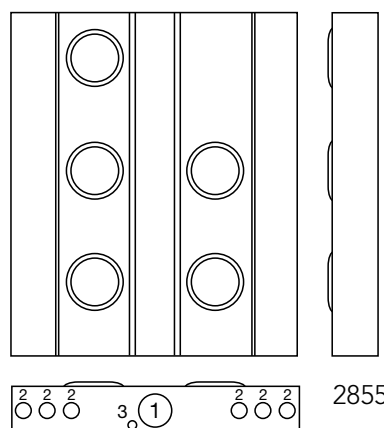
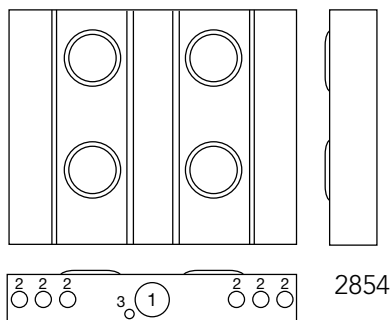
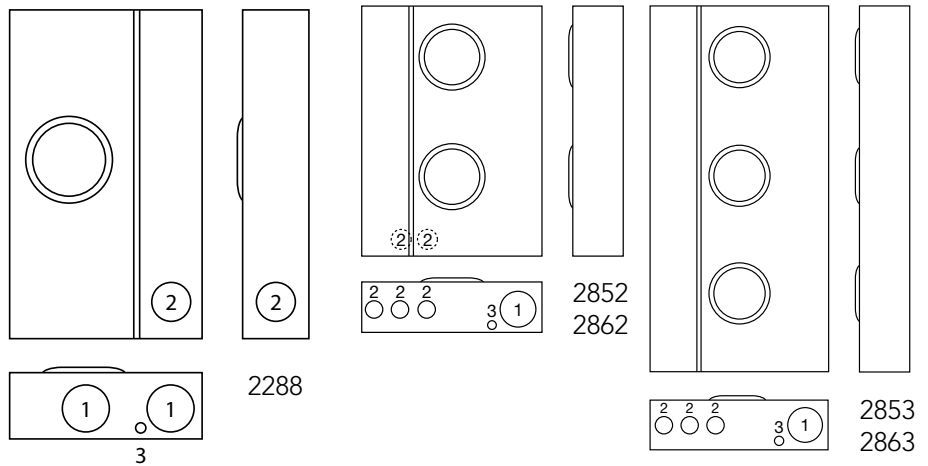

Please consult serving utility for their requirements prior to ordering or installing, as specifications and approvals vary by utility, and may require local electrical inspector approval. All installations must be installed by a licensed electrician and must comply with all national and local codes, laws and regulations. Milbank reserves the right to make changes in specifications and features shown without notice or obligation.



Multi-Position Meter Mains

125 Amps per Position | 22K SCCR Rated | 240 VAC



U5902-X-BL

125 Amps | 4 Terminals | Ringless | 1Ø3W

Catalog Number	Service	Main Bus Rating	Hub	Connectors CU/AL - Line	Dimensions			Knockouts				
					D"	W"	H"	1	2	3	4	5
U5902-X-BL	OH/UG	200 Amps	C.P.	¾" x 16 Studs	5⅞	26½	30	3	2½	1	⅞	¼
U5903-X-BL	OH/UG	300 Amps	C.P.	¾" x 16 Studs	5⅞	34⅝	30	3	2½	1	1	—
U5904-X-BL	OH/UG	400 Amps	C.P.	¾" x 16 Studs	4½	42⅞	30	3	2½	2½	1	—
U5905-X-BL	OH/UG	500 Amps	C.P.	¾" x 16 Studs	5⅞	51	30	3	2½	2½	1	—
U5906-X-BL	OH/UG	600 Amps	C.P.	¾" x 16 Studs	4½	59 ⅜	30	3	2½	1	⅞	¼

Notes

- **Knockouts:** See page 42.
- **AIC Rating:** All models are rated 22K AIC when used with approved breakers rated at 22K.
- **NEC 2020 Compliant:** All products are NEC 2020 compliant.
- **Hubs:** Units supplied with one closing plate. To order separately, see the hub suffix chart on the accessories page.
- **Fifth Terminal:** For field-installable fifth terminal, order K5T.
- **BL:** Barrel lock provision.
- **Optional:** Factory installed breakers are available—consult factory.
- **Line Side Connectors:** Socket is supplied with ⅜" - 16 hex head nuts with Belleville washers. Separate lug kits are required for line side.
- **Load Side Connectors:** Dependant upon field-installed breaker.

Breaker Chart - 10K AIC (unless noted 22K)

Manufacturer	Cutler-Hammer	Siemens	GE (50 Amps Max)	Sqaure D
125 Amps or Less	BR, HQP, QPGF	QP, (QPH 22K)	THQL, THQL-GF	Homeline



Please consult serving utility for their requirements prior to ordering or installing, as specifications and approvals vary by utility, and may require local electrical inspector approval. All installations must be installed by a licensed electrician and must comply with all national and local codes, laws and regulations. Milbank reserves the right to make changes in specifications and features shown without notice or obligation.

Multi-Position Meter Mains

200 Amps per Position | 22K SCCR Rated | 240 VAC



U5882-X-BL

Connector Kits

Size	Suffix	Kit Number	Wire Range
Single	-K1	K1539	#6-350
	-K3	K1540	#4-600
Twin	-K2	K1350	#6-350
	-K4	K1541	#2-600

200 Amps | 4 Terminals | Ringless | 1Ø3W

Catalog Number	Amps	Service	Main Bus Rating	Hub	Connectors CU/AL - Line	Dimensions		
						D"	W"	H"
U5882-X-BL	200	OH/UG	320 Amps	C.P.	3/8" x 16 Studs	5 ¹³ / ₁₀₀	26 ¹ / ₂	30
U5883-X-BL	200	OH/UG	480 Amps	C.P.	3/8" x 16 Studs	5 ¹³ / ₁₀₀	34 ¹⁴ / ₂₅	30
U5884-X-BL	200	OH/UG	640 Amps	C.P.	3/8" x 16 Studs	4 ¹ / ₂	42 ¹ / ₈	30
U5885-X-BL	200	OH/UG	640 Amps	C.P.	3/8" x 16 Studs	5 ¹³ / ₁₀₀	51	30
U5886-X-BL	200	OH/UG	640 Amps	C.P.	3/8" x 16 Studs	4 ¹ / ₂	59 ³¹ / ₁₀₀	30

Notes

- **Knockouts:** See next page for knockout information.
- **NEC 2020 Compliant:** All products are NEC 2020 compliant.
- **Short Circuit Current Rating:** All models are rated 22K when used with approved breakers rated at 22K.
- **Hubs:** Units supplied with one closing plate. To order separately, see the hub suffix chart on the accessories page.
- **Fifth Terminal:** For field-installable fifth terminal, order **K5T**.
- **-BL:** Barrel lock provision.
- **Line Side Connectors:** Socket is supplied with 3/8" - 16 hex head nuts with Belleville washers. Separate lug kits are required for line side.
- **Load Side Connectors:** Dependant upon field-installed breaker.

Breaker Chart - 10K AIC | For 22K AIC use Siemens QPH or QNH

Manufacturer	Cutler-Hammer	Siemens	GE (50 Amps Max)	Sqaure D
125 Amps or Less	BR, HQP, QPGF	QP, (QPH 22K)	THQL, THQL-GF	Homeline
150-200 Amps	—	QN, (QNH 22K)	—	—

Please consult serving utility for their requirements prior to ordering or installing, as specifications and approvals vary by utility, and may require local electrical inspector approval. All installations must be installed by a licensed electrician and must comply with all national and local codes, laws and regulations. Milbank reserves the right to make changes in specifications and features shown without notice or obligation.



Multi-Position Meter Mains

Knockout Information

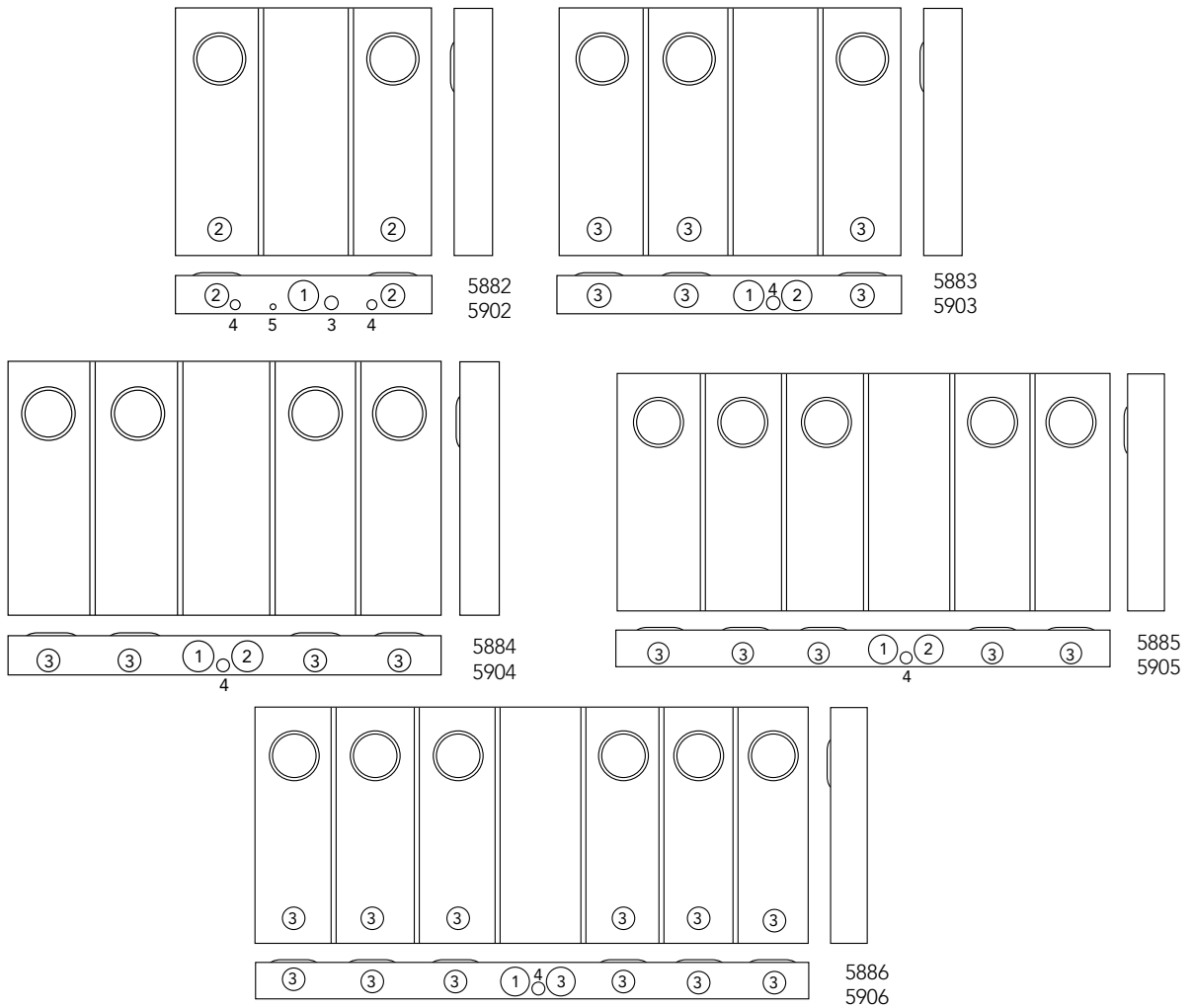

U5882-86 Series

Dimensions			Knockouts				
D"	W"	H"	1	2	3	4	5
5 ¹³ / ₁₀₀	26½	30	3	2½	1	7/8	¼
5 ¹³ / ₁₀₀	34 ¹⁴ / ₂₅	30	3	2½	2½	1	—
4½	42 ⁷ / ₈	30	3	2½	2½	1	—
5 ¹³ / ₁₀₀	51	30	3	3	2½	1	—
4½	59 ³¹ / ₁₀₀	30	3	2½	2½	1	—

U5902-06 Series

Dimensions			Knockouts				
D"	W"	H"	1	2	3	4	5
5 ¹³ / ₁₀₀	26½	30	3	2½	1	7/8	¼
5 ¹³ / ₁₀₀	34 ¹⁴ / ₂₅	30	3	2½	1	1	—
4½	42 ⁷ / ₈	30	3	2½	2½	1	—
5 ¹³ / ₁₀₀	51	30	3	2½	2½	1	—
4½	59 ³¹ / ₁₀₀	30	3	2½	1	7/8	¼



Please consult serving utility for their requirements prior to ordering or installing, as specifications and approvals vary by utility, and may require local electrical inspector approval. All installations must be installed by a licensed electrician and must comply with all national and local codes, laws and regulations. Milbank reserves the right to make changes in specifications and features shown without notice or obligation.

Lever Bypass Multi-Position Meter Mains

43

200 Amps | 5 Terminals | Ringless | 120/240 VAC



U4374-Xt-5T9

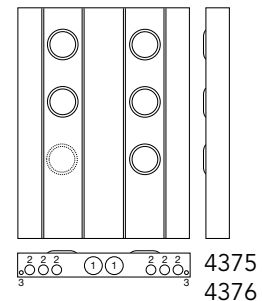
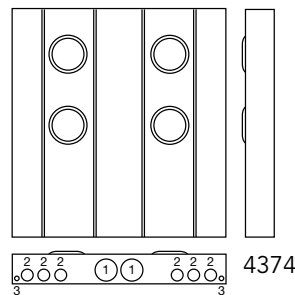
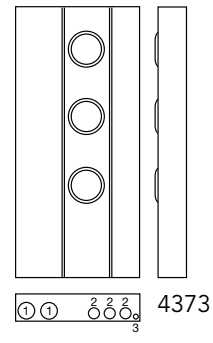
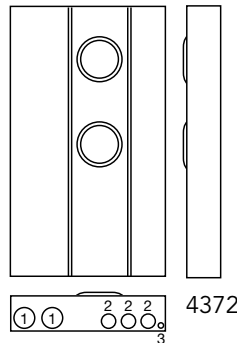

200 Amps per Position | 5 Terminals | Ringless | 1Ø3W

Catalog Number	Positions	Service	Main Bus Rating	Line Connector Size	Dimensions			Knockouts		
					D"	W"	H"	1	2	3
U4372-Xt-5T9	2	OH/UG	320 Amps	3/8" x 16 Studs*	6	27 3/4	48	3	2	1/4, 1/2
U4373-Xt-5T9	3	OH/UG	480 Amps	3/8" x 16 Studs*	6	27 3/4	60	3	2	1/4, 1/2
U4374-Xt-5T9	4	OH/UG	640 Amps	3/8" x 16 Studs*	6	45	48	4	2	1/4, 1/2
U4375-Xt-5T9	5	OH/UG	640 Amps	3/8" x 16 Studs*	6	45	60	4	2	1/4, 1/2
U4376-Xt-5T9	6	OH/UG	640 Amps	3/8" x 16 Studs*	6	45	60	4	2	1/4, 1/2

Connector Kits*

Size	Suffix	Kit Number	Wire Range
Single	-K3	K1540	#4-600
Twin	-K2	K1350	#6-350
	-K4	K1541	#2-600

Breaker Chart

Manufacturer	150-200 Amps	125 Amps or Less
Cutler-Hammer	BJ, WBJ	Quicklag P BR, HQP
Siemens (ITE)	QNR	QP
Murray	MD	MP
GE	—	Q Line
Square D	—	Homeline

Notes

- **Breakers:** Units have provision for one 2-pole main per meter position. Breakers not included. Order as extra (see chart above).
- **Bypass:** Lever supplies clamping action on meter spades and also operates bypass device.
- *Connectors: For line wire connector kits, order separately (see chart above).

Please consult serving utility for their requirements prior to ordering or installing, as specifications and approvals vary by utility, and may require local electrical inspector approval. All installations must be installed by a licensed electrician and must comply with all national and local codes, laws and regulations. Milbank reserves the right to make changes in specifications and features shown without notice or obligation.



Multi-Position Meter Mains

200 Amps | Lever Bypass | 22K SCCR Rated | 240 VAC



U5972-Xt-5T9-BL

Connector Kits

Size	Suffix	Kit Number	Wire Range
Single	-K1	K1539	#6-350
	-K3	K1540	#4-600
Twin	-K2	K1350	#6-350
	-K4	K1541	#2-600

200 Amps | 5 Terminals | Ringless | Lever Bypass

Catalog Number	Positions	Service	Main Bus Rating	Hub	Connectors CU/AL	Dimensions			Knockouts				
					Line	D"	W"	H"	1	2	3	4	
U5972-Xt-5T9-BL	2	OH/UG	320 Amps	(2) C.P.	3/8" x 16 Studs	5 ³ / ₃₂	36 ³ / ₈	34	4	2 ¹ / ₂	1	1/2	
U5973-Xt-5T9-BL	3	OH/UG	480 Amps	(2) C.P.	3/8" x 16 Studs	5 ³ / ₃₂	46 ¹ / ₂	34	4	2 ¹ / ₂	1		
U5974-Xt-5T9-BL	4	OH/UG	640 Amps	(2) C.P.	3/8" x 16 Studs	5 ³ / ₃₂	57 ¹ / ₁₆	34	4	2 ¹ / ₂	1		
U5975-Xt-5T9-BL	5	OH/UG	640 Amps	(2) C.P.	3/8" x 16 Studs	5 ³ / ₃₂	67 ¹ / ₈	34	4	2 ¹ / ₂	1		
U5976-Xt-5T9-BL	6	OH/UG	640 Amps	(2) C.P.	3/8" x 16 Studs	5 ³ / ₃₂	77 ¹ / ₁₆	34	4	2 ¹ / ₂	1		

Notes

- **Knockouts:** See drawings on following page.
- **Short Circuit Current Rating:** All models are rated 22K AIC when used with approved breakers rated at 22K.
- **Bypass:** These units have locking jaw lever bypass.
- **Hubs:** Units supplied with two closing plate. To order separately, see the hub suffix chart on the accessories page.
- **Fifth Terminal:** Fifth terminals are factory installed in the 9 o'clock position.
- **-BL:** Barrel lock provision.
- **Line Side Connectors:** Socket is supplied with 3/8" - 16 hex head nuts with Belleville washers. Separate lug kits are required for line side.
- **Load Side Connectors:** Dependant upon field-installed breaker.

Breaker Chart - 10K AIC (unless noted 22K)

Manufacturer	Cutler-Hammer	Siemens	GE (50 Amp Max)	Square D
125 Amps or Less	BR, HQP, QPGF	QP (QPH 22K)	THQL, THQL-GF	Homeline
150-200 Amps	—	QN (QNH 22K)	—	—



Please consult serving utility for their requirements prior to ordering or installing, as specifications and approvals vary by utility, and may require local electrical inspector approval. All installations must be installed by a licensed electrician and must comply with all national and local codes, laws and regulations. Milbank reserves the right to make changes in specifications and features shown without notice or obligation.

Multi-Position Meter Mains

Knockout Information

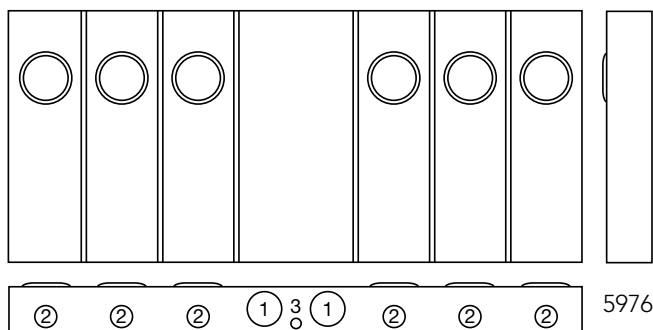
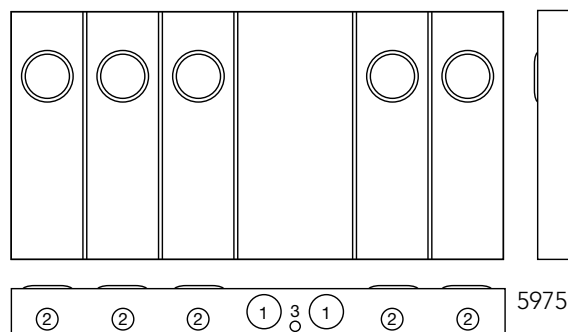
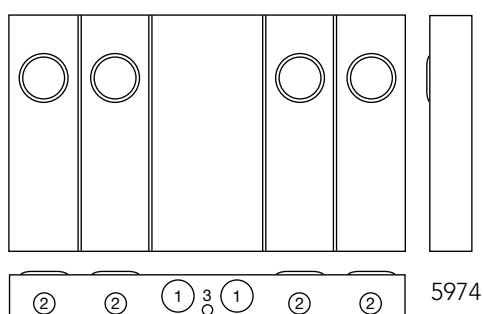
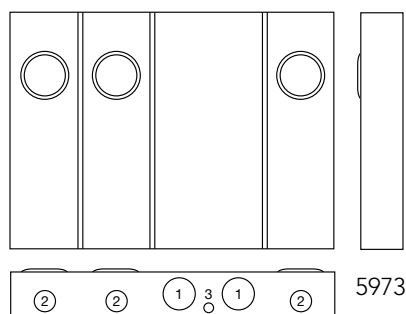
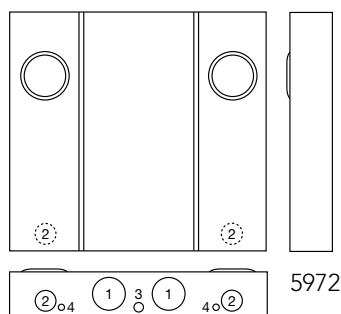

Dimensions			Knockouts			
D"	W"	H"	1	2	3	4
5 ³ / ₃₂	36 ³ / ₈	34	4	2 ¹ / ₂	1	1 ¹ / ₂
5 ³ / ₃₂	46 ¹ / ₂	34	4	2 ¹ / ₂	1	—
5 ³ / ₃₂	57 ¹ / ₁₆	34	4	2 ¹ / ₂	1	—
5 ³ / ₃₂	67 ¹ / ₈	34	4	2 ¹ / ₂	1	—
5 ³ / ₃₂	77 ¹ / ₁₆	34	4	2 ¹ / ₂	1	—

Please consult serving utility for their requirements prior to ordering or installing, as specifications and approvals vary by utility, and may require local electrical inspector approval. All installations must be installed by a licensed electrician and must comply with all national and local codes, laws and regulations. Milbank reserves the right to make changes in specifications and features shown without notice or obligation.



46 Plunger Bypass Transformer Rated Sockets

20 Amps | 6-13 Terminals | 600 VAC



UC1299-XL

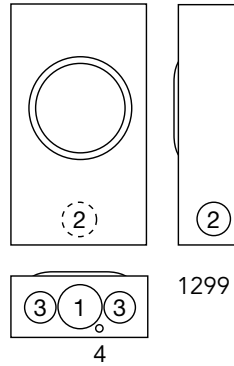

1299

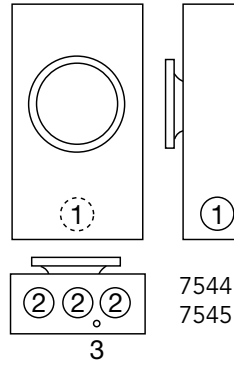

7544
7545



UC7545-RL

20 Amps | Transformer Rated Sockets

Catalog Number	Type	Terminals	Hub	Meter Form	Connectors CU	Bypass	Dimensions			Knockouts			
							D"	W"	H"	1	2	3	4
UC1299-XL	Ringless	6	C.P.	4S	#14 - 4	Plunger	3 ⁵ / ₁₆	8	14	2	1 ¹ / ₂	1 ¹ / ₄	1 ¹ / ₄
UC7544-RL	Ring Type	8	H.O.	5S	#14 - 4	Plunger	3 ⁵ / ₁₆	8	14	1 ¹ / ₂	1 ¹ / ₄	1 ¹ / ₄	—
UC7545-RL	Ring Type	13	H.O.	6, 8, 9S & (ALT) 10S	#14 - 4	Plunger	3 ⁵ / ₁₆	8	14	1 ¹ / ₂	1 ¹ / ₄	1 ¹ / ₄	—

Notes

- **Hubs:** For proper hub selection, see the hub suffix chart on the accessories page.
- **Bypass:** Plunger type bypass automatically closes when meter is removed.
- **Connectors:** Units are supplied with mechanical type connectors.
- **Sealing Ring:** The ring type **UC7544** and **UC7545** units include a MR-2 snap type sealing ring.



Please consult serving utility for their requirements prior to ordering or installing, as specifications and approvals vary by utility, and may require local electrical inspector approval. All installations must be installed by a licensed electrician and must comply with all national and local codes, laws and regulations. Milbank reserves the right to make changes in specifications and features shown without notice or obligation.

Transformer Rated Sockets

20 Amps | 6-13 Terminals | 600 VAC

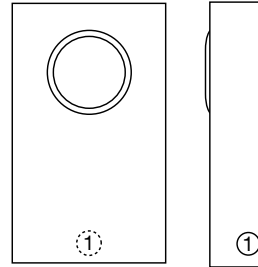

7448
7449
7532

U7449-XL

20 Amps | Transformer Rated Sockets | 2-Piece Cover

Catalog Number	Terminals	Meter Form	Hub	Connectors CU	Bypass	Dimensions			Knockouts	
						D"	W"	H"	1	2
UC7532-XL	6	4S	C.P.	#14 - 4	Test Switch Provision	4 1/8	12	20	1 1/4	1/4, 1/2
UC7448-XL	8	5S	C.P.	#14 - 4	Test Switch Provision	4 1/8	12	20	1 1/4	1/4, 1/2
UC7449-XL	13	6, 8, 9S & (ALT) 10S	C.P.	#14 - 4	Test Switch Provision	4 1/8	12	20	1 1/4	1/4, 1/2

Notes

- **Hubs:** For proper hub selection, see the hub suffix chart on the accessories page.
- **Connectors:** Supplied with tin-plated mechanical connectors (#4 maximum).

Please consult serving utility for their requirements prior to ordering or installing, as specifications and approvals vary by utility, and may require local electrical inspector approval. All installations must be installed by a licensed electrician and must comply with all national and local codes, laws and regulations. Milbank reserves the right to make changes in specifications and features shown without notice or obligation.



Transformer Rated Sockets

20 Amps | 6-13 Terminals | 600 VAC



UC7445-O-311-NOE

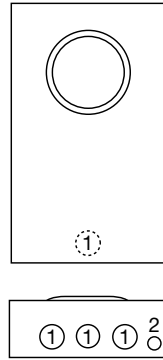

7444
7445
7478

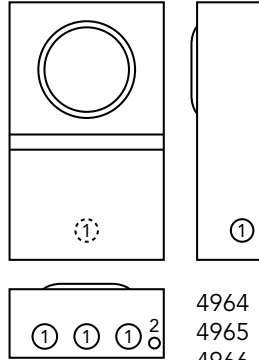

4964
4965
4966



UC4966-O-WC-21-NST

20 Amps | Transformer Rated Sockets | With Prewired Test Switch | **Approved for Eversource in CT & W. MA**

Catalog Number	Terminals	Meter Form	Cover	Hub	Connectors CU	Bypass	Dimensions			Knockouts	
							D"	W"	H"	1	2
UC7478-O-81-NOE	6	4S	1 Piece	Blank	#14 - 4	Test Switch	4 $\frac{1}{8}$	12	20	1 $\frac{1}{4}$	1 $\frac{1}{4}$, 1 $\frac{1}{2}$
UC7444-O-141-NOE	8	5S	1 Piece	Blank	#14 - 4	Test Switch	4 $\frac{1}{8}$	12	20	1 $\frac{1}{4}$	1 $\frac{1}{4}$, 1 $\frac{1}{2}$
UC7445-O-311-NOE	13	6, 8, 9S & (ALT) 10S	1 Piece	Blank	#14 - 4	Test Switch	4 $\frac{1}{8}$	12	20	1 $\frac{1}{4}$	1 $\frac{1}{4}$, 1 $\frac{1}{2}$

20 Amps | Transformer Rated Sockets | with Prewired Test Switch | **Approved for Eversource in MA**

Catalog Number	Terminals	Meter Form	Cover	Hub	Connectors CU	Bypass	Dimensions			Knockouts	
							D"	W"	H"	1	2
UC4964-O-WC-21-NST	6	4S	2 Piece	Blank	#14 - 4	Test Switch	5 $\frac{1}{8}$	12	20	2	1 $\frac{1}{4}$, 1 $\frac{1}{2}$
UC4965-O-WC-21-NST	8	5S	2 Piece	Blank	#14 - 4	Test Switch	5 $\frac{1}{8}$	12	20	2	1 $\frac{1}{4}$, 1 $\frac{1}{2}$
UC4966-O-WC-21-NST	13	6, 8, 9S & (ALT) 10S	2 Piece	Blank	#14 - 4	Test Switch	5 $\frac{1}{8}$	12	20	2	1 $\frac{1}{4}$, 1 $\frac{1}{2}$

Notes

- **Hubs:** For proper hub selection, see the hub suffix chart on the accessories page.
- **Connectors:** Supplied with tin-plated mechanical connectors (#4 maximum).



Please consult serving utility for their requirements prior to ordering or installing, as specifications and approvals vary by utility, and may require local electrical inspector approval. All installations must be installed by a licensed electrician and must comply with all national and local codes, laws and regulations. Milbank reserves the right to make changes in specifications and features shown without notice or obligation.

Test Switches

4, 7 & 10 Pole

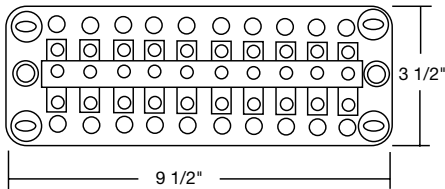
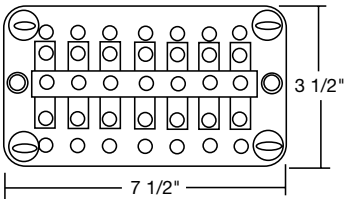
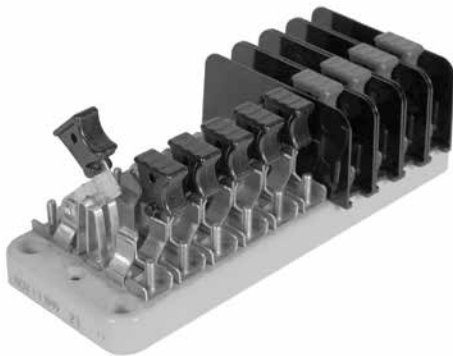

Key	
P	Potential Switch
C+	Line side current switch with short circuit assembly
C	Load side current switch with test jack assembly
N	Neutral bar (no switch)
Pn	Neutral Potential Switch
X	Unused Position on base
	Insulating barrier, isolates both sides of switch

Catalog Number	4-Pole						
TS04-0101	X	P		X	C+	C	X
TS04-0102	X		C+	C	X	Pn	X
TS04-0103	X	P		X	C	C+	X
TS04-0104	X	C+	C	X	P		X

Notes

- 4-pole switches are also available on 10-pole bases. Contact Milbank for appropriate catalog numbers.

Catalog Number	7-Pole						
TS07-0105		P		C+	C	C+	C
TS07-0106		C+	C		C+	C	
TS07-0107		P		C	C+	C	C+
TS07-0108	C+	C	C+	C		P	

Notes

- 4-pole switches are also available on 10-pole bases. Contact Milbank for appropriate catalog numbers.

Catalog Number	7-Pole on a 10-Pole Base									
TS07-0049		X		X		X	C+	C	C	C+
TS07-0018		X		X		X	C+	C	C+	C
TS07-0059	X		C+	C		C	C+		X	X
TS07-0022	P	X	P	X	Pn	X	C	C+	C	C+

Catalog Number	10-Pole									
TS10-0109	P		P		C+	C	C+	C	C+	C
TS10-0110		C+	C		C+	C		C+	C	
TS10-0111	P		P		C	C+	C	C+	C	C+
TS10-0112	C+	C	C+	C	C+	C		P		

Please consult serving utility for their requirements prior to ordering or installing, as specifications and approvals vary by utility, and may require local electrical inspector approval. All installations must be installed by a licensed electrician and must comply with all national and local codes, laws and regulations. Milbank reserves the right to make changes in specifications and features shown without notice or obligation.





U1855-O-NE

Current Transformer Enclosures

Catalog Number	Amperage Rating	Hub	Steel Gauge	Connectors CU/AL	Dimensions		
					D"	W"	H"
U1855-O-NE	400–800	Blank	12	3 connectors per phase	12	36	36
U1856-O-NE	801-1200	Blank	12	5 connectors per phase	12	48	48
U6568-O-NE	801-1200	Blank	12	6 connectors per phase	12½	53	60¼

Notes

- **Features:** These enclosures have three-point locking handles, lift-off hinges with stainless steel pins and two doors. NEMA 3R rated.
- **Connectors:** Minimum #4, maximum 600 MCM.
- **Isolated Neutrals:** U1855 and U1856 both come from the factory with isolated neutrals. Bonding straps are included but not attached with each enclosure if isolated neutral is not needed.
- **United Illuminating:** U6568 is UI approved.



Please consult serving utility for their requirements prior to ordering or installing, as specifications and approvals vary by utility, and may require local electrical inspector approval. All installations must be installed by a licensed electrician and must comply with all national and local codes, laws and regulations. Milbank reserves the right to make changes in specifications and features shown without notice or obligation.

Test Cabinet

5 1

with Pre-Drilled Test Switch Bridge

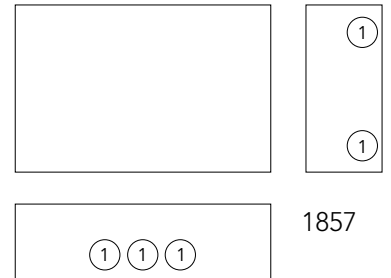
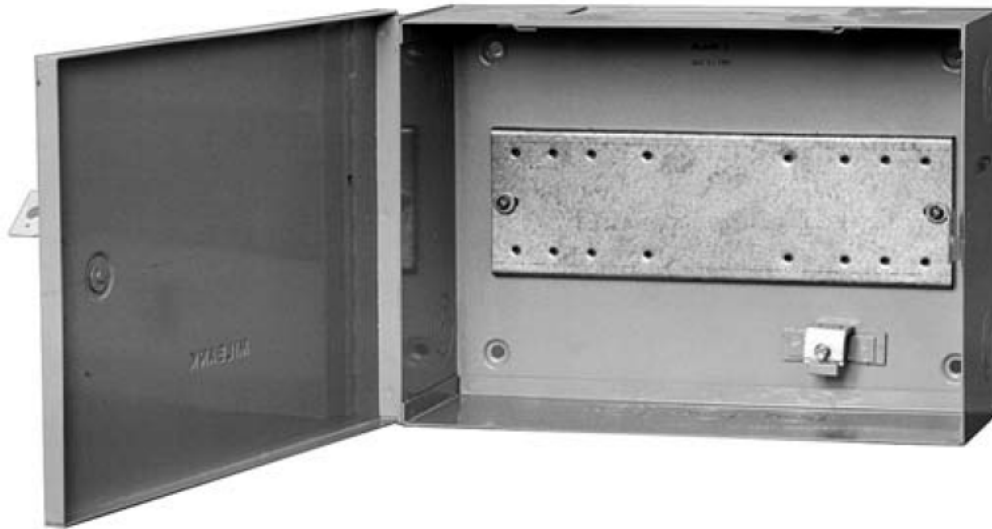

S1857

Test Cabinet

Catalog Number	Hub	Dimensions			Knockouts
		D"	W"	H"	1
S1857	Blank	4½	14	10	1¼

Notes

- **Features:** Test cabinet has a piano-hinged cover and pre-drilled test switch bridge. The top of the enclosure has a rectangular knockout for bussing.

Please consult serving utility for their requirements prior to ordering or installing, as specifications and approvals vary by utility, and may require local electrical inspector approval. All installations must be installed by a licensed electrician and must comply with all national and local codes, laws and regulations. Milbank reserves the right to make changes in specifications and features shown without notice or obligation.



S2718-FB-XL-C



S3390-FB-XL-C7

Polyphase Enclosures

Catalog Number	Number of Positions	Hub	Dimensions		
			D"	W"	H"
S2718-FB-XL-C	1	C.P.	14	15	34 ¹¹ / ₁₆
S3390-FB-XL-C7	2	C.P.	11	28	34 ¹¹ / ₁₆

Notes

- **Features:** Units are supplied with full board and one demand reset cover per meter position. Cover holding arms included.



Please consult serving utility for their requirements prior to ordering or installing, as specifications and approvals vary by utility, and may require local electrical inspector approval. All installations must be installed by a licensed electrician and must comply with all national and local codes, laws and regulations. Milbank reserves the right to make changes in specifications and features shown without notice or obligation.

Universal Meter Pedestal Unit

53

For Pad-mounting Applications

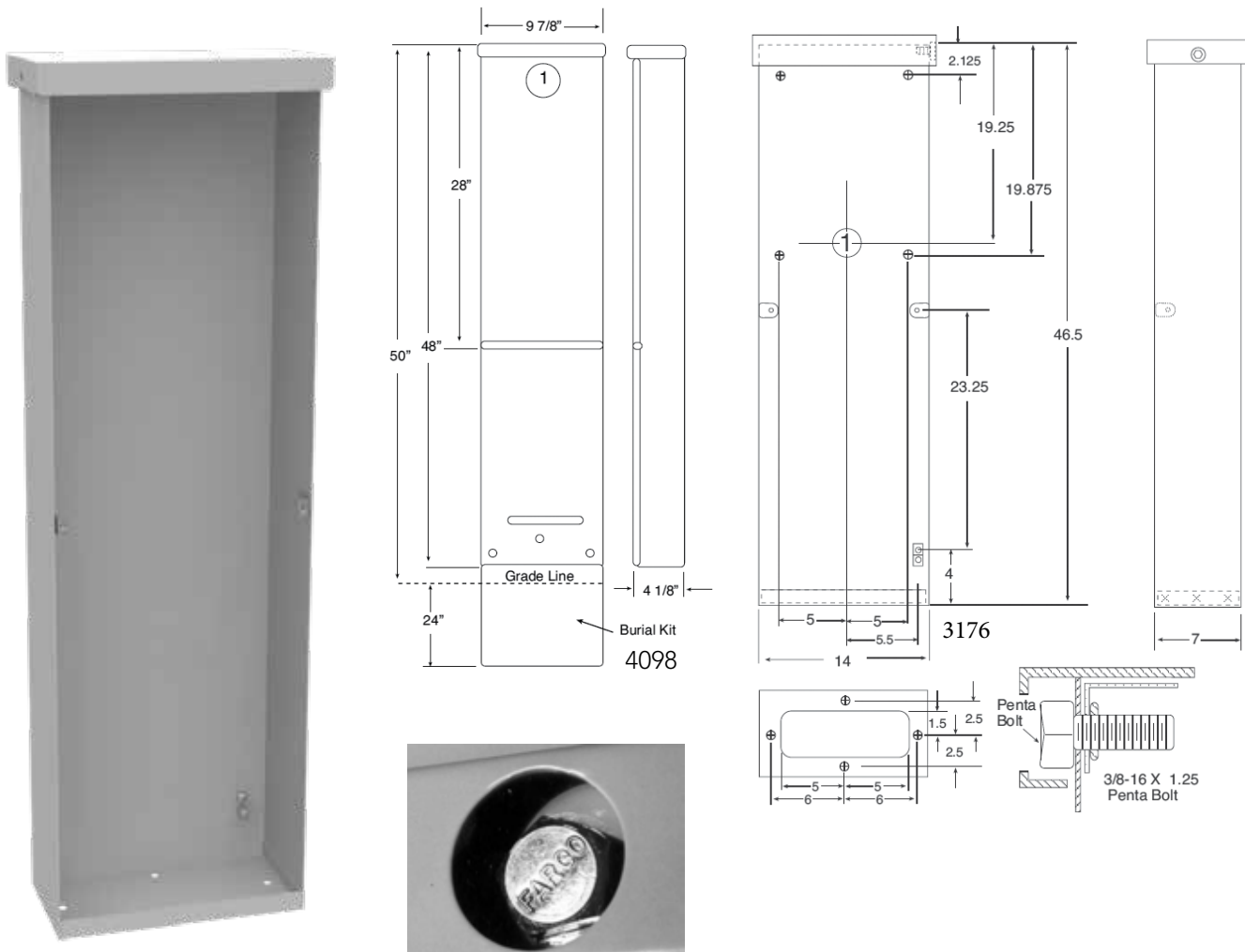

S3176-O

Penta Bolt locking mechanism

Universal Meter Pedestal Units for Pad-mounting

Catalog Number	Hub	Application	Service	Dimensions			Knockouts
				D"	W"	H"	1
S3176-O	Blank	Pad-mounted pedestal	UG	7	14	46½	1¼
S4098-O	Blank	See Note Below	UG	4⅞	9⅞	48	2½

Notes

- **Direct Burial Kit:** Direct bury kit **K3236** and stabilizer foot **K3188** are included for **S4098-O**. Pad-mount sleeve **K3237** must be ordered separately.
- **Connectors:** Supplied with tin-plated mechanical connectors (#4 maximum).

Please consult serving utility for their requirements prior to ordering or installing, as specifications and approvals vary by utility, and may require local electrical inspector approval. All installations must be installed by a licensed electrician and must comply with all national and local codes, laws and regulations. Milbank reserves the right to make changes in specifications and features shown without notice or obligation.



54 Meter Main with Load Center Pedestals

200 Amps | 4 Terminals | Ringless | 120/240 VAC



U5136-O-200S-NHB

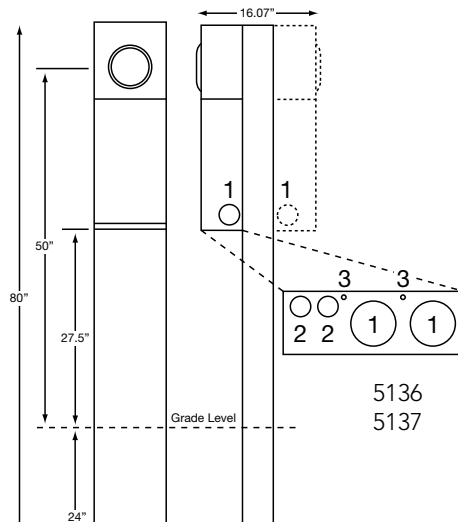

U5138-O-200S-NHB

200 Amps | 4 Terminals | Ringless

Catalog Number	Service	No. of Positions	Mount	Connectors CU/AL		AIC Rating	Dimensions			Knockouts		
				Line	Load		D"	W"	H"	1	2	3
U5136-O-200S-NHB	UG	1	Direct bury	#6-350	CB	22K	4 $\frac{1}{8}$	9 $\frac{7}{8}$	80	2	1 $\frac{1}{2}$, 3 $\frac{3}{4}$	1 $\frac{1}{4}$
U5137-O-200S-NHB	UG	2	Direct bury	#6-350	CB	22K	4 $\frac{1}{8}$	9 $\frac{7}{8}$	80	2	1 $\frac{1}{2}$, 3 $\frac{3}{4}$	1 $\frac{1}{4}$
U5138-O-200S-NHB	UG	1	Pad mount	#6-350	CB	22K	4 $\frac{1}{8}$	9 $\frac{7}{8}$	80	2	1 $\frac{1}{2}$, 3 $\frac{3}{4}$	1 $\frac{1}{4}$
U5139-O-200S-NHB	UG	2	Pad mount	#6-350	CB	22K	4 $\frac{1}{8}$	9 $\frac{7}{8}$	80	2	1 $\frac{1}{2}$, 3 $\frac{3}{4}$	1 $\frac{1}{4}$

Notes

- **NEC 2020 Compliant:** Meets requirements for sections 230.62 and 230.85.
- **Fifth Terminal:** For field-installable fifth terminal, order **K5T**.
- **Stabilizer Foot:** For field-installable stabilizer foot, order **K5415**.
- **Penta Bolt Locking:** For field-installable pedestal fronts with penta bolt locking, order **K5039**.
- **Receptacles:** Consult factory for installed receptacle assemblies.
- **Short Circuit Current Rating:** 22K AIC. However, this rating is limited to the lowest interrupting capacity of any circuit breaker installed. Watt-hour meter not included in short circuit current rating. Unit is supplied with **UQFPH-M-200** breaker.
- **U5137:** Double powerhead version.

K5415 - Stabilizer foot with hardware (recommended for double pedestals)	K5035 - Pad-mount kit with hardware; required for U5138/ U5139 pad-mount	K5T - Fifth terminal kit for 208y/120 VAC 3-wire service	K5193 - Bus kit to convert series-wired main breaker to parallel	K5194 - But kit to convert parallel-wired main breaker to series	K3450 -Telephone/ CATV mounting bracket (mounts left to right)



Please consult serving utility for their requirements prior to ordering or installing, as specifications and approvals vary by utility, and may require local electrical inspector approval. All installations must be installed by a licensed electrician and must comply with all national and local codes, laws and regulations. Milbank reserves the right to make changes in specifications and features shown without notice or obligation.

Meter Main with Load Center Pedestals

55

100-200 Amps | 5 Terminals | Ringless | 120/240 VAC



U5701-O-200S

Picture shown with bridge installed.
(Catalog number: K5400-BRIDGE-3POS)

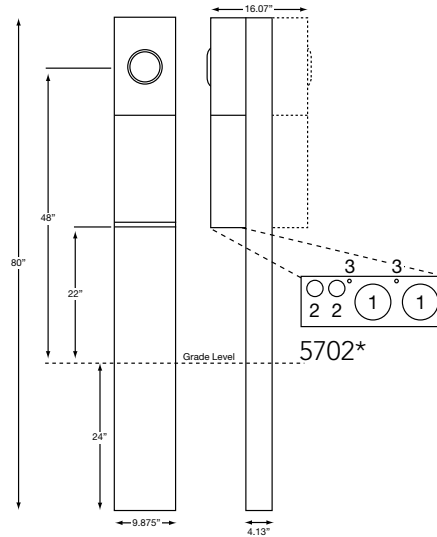

100-200 Amps | 5 Terminals | Meter Main Pedestals | Heavy Duty Lever Bypass | Ringless | 1Ø3W

Catalog Number	Meter Positions	Circuit Provisions	Mounting Type	Twin Line Connectors CU/AL	Dimensions			Knockouts		
					D"	W"	H"	1	2	3
U5701-O-100S	Single	4	D.B. Post	#6-350	4 $\frac{1}{8}$	9 $\frac{7}{8}$	80	2	$\frac{3}{4}$	$\frac{1}{4}$
U5701-O-150S	Single	4	D.B. Post	#6-350	4 $\frac{1}{8}$	9 $\frac{7}{8}$	80	2	$\frac{3}{4}$	$\frac{1}{4}$
U5701-O-200S	Single	4	D.B. Post	#6-350	4 $\frac{1}{8}$	9 $\frac{7}{8}$	80	2	$\frac{3}{4}$	$\frac{1}{4}$

Notes

- **NEC 2020 Compliant:** Meets requirements for sections 230.62 and 230.85.
- **Bypass:** Lever provides clamping action on meter spades and also operates bypass device.
- **Fifth Terminal:** For field-installable fifth terminal, kit order K5T.
- **Branch Circuit Breakers:** For **U5701**, quadplex style breakers may be used in accordance with the NEC. If main breaker is used, there are provisions for two 2-pole breakers or four 1-pole breakers in series. Branch interior of **U5701** accepts most manufacturers' small frame plug-in type circuit breakers (GE, Siemens, Cutler-Hammer, Murray).
- **Kits:** For **5701** and **5702**, order stabilizer kit **K5415**. For **5703**, order pad-mount kit **K5035**.
- **Receptacles:** If receptacles are required, contact factory for additional kit information. Two outlet devices maximum can be installed.

Please consult serving utility for their requirements prior to ordering or installing, as specifications and approvals vary by utility, and may require local electrical inspector approval. All installations must be installed by a licensed electrician and must comply with all national and local codes, laws and regulations. Milbank reserves the right to make changes in specifications and features shown without notice or obligation.



Temporary Power Units

125 Amps | 4 Terminals | Ringless | 120/240 VAC



125 Amps | 4 Terminals | Temporary Power Units | Ringless | 1Ø3W

Catalog Number	Amps	Service	Hub	Connectors CU/AL		Dimensions			Knockouts				
				Line	Load	D"	W"	H"	1	2	3	4	5
U4908-O-11GR	125	UG	Blank	#6-2/0	CB	5 ³ / ₁₆	9	25 ¹⁵ / ₁₆	2	1 ¹ / ₂	1 ¹ / ₄	1 ¹ / ₄	—
U4908-O-100MB-11GR*	125	UG	Blank	#6-2/0	CB	5 ³ / ₁₆	9	25 ¹⁵ / ₁₆	2	1 ¹ / ₂	1 ¹ / ₄	1 ¹ / ₄	—

4125 Amps | Terminals | Temporary Power Units | Ringless | 1Ø3W

Catalog Number	Amps	Service	Hub	Connectors CU/AL		Dimensions			Knockouts				
				Line	Load	D"	W"	H"	1	2	3	4	5
U5101-XL-11GR	125	OH	C.P.	#6-250	CB	5 ³ / ₁₆	8 ⁷ / ₈	25	2	1 ¹ / ₂	1 ¹ / ₄	1 ¹ / ₄	—
U5101-XL-100MB-11GR*	125	OH	C.P.	#6-250	CB	5 ³ / ₁₆	8 ⁷ / ₈	25	2	1 ¹ / ₂	1 ¹ / ₄	1 ¹ / ₄	—

Notes

- **NEC 2020:** Includes 100 Amps Breaker.
- **Interior:** Six-circuit plated copper interior accepts standard plug-in type circuit breakers.
- **Receptacle Bridge:** Three position self-grounded receptacle bridge accepts most standard NEMA receptacles with mounting plates.
- **Included Parts:** U4908 and U5101 come supplied with two 20 Amps 1-pole breakers and two 20 Amps GFCI receptacles (prewired and installed).

*Includes a 100 Amps breaker and is compliant for NEC 2020 requirements.



Please consult serving utility for their requirements prior to ordering or installing, as specifications and approvals vary by utility, and may require local electrical inspector approval. All installations must be installed by a licensed electrician and must comply with all national and local codes, laws and regulations. Milbank reserves the right to make changes in specifications and features shown without notice or obligation.

Circuit Breakers

57

UQFP Plug-In & UQFB Bolt-On Series | 120/240 VAC



UQFP
UQFPH



UQFP-M
UQFPH-M



UQFB-X1



UQFBH

200 Amps Frame | Plug-In | 10,000 AIC & 22,000 AIC | Two-Pole - Common Trip

Amps	10K AIC Plug-In	22K AIC Plug-In	10K AIC Plug-In	22K AIC Plug-In	Wire Range	
					CU	AL
100	UQFP-100	UQFPH-100	UQFP-M-100	UQFPH-M-100	#3-#1	#1-1/0
125	UQFP-125	UQFPH-125	UQFP-M-125	UQFPH-M-125	#3-#1	#1-1/0
150	UQFP-150	UQFPH-150	UQFP-M-150	UQFPH-M-150	1/0-300	2/0-300
175	UQFP-175	UQFPH-175	UQFP-M-175	UQFPH-M-175	1/0-300	2/0-300
200	UQFP-200	UQFPH-200	UQFP-M-200	UQFPH-M-200	1/0-300	2/0-300

200 Amps Frame | Bolt-On | 10,000 AIC & 22,000 AIC | Two-Pole - Common Trip

Amps	10K AIC Bolt-On	22K AIC Bolt-On	10K AIC Bolt-On	22K AIC Bolt-On	Wire Range	
					CU	AL
100	UQFB-100	UQFBH-100	UQFB-100-X1	UQFBH-M-100	#3-#1	#1-1/0
125	UQFB-125	UQFBH-125	UQFB-125-X1	UQFBH-M-125	#3-#1	#1-1/0
150	UQFB-150	UQFBH-150	UQFB-150-X1	UQFBH-M-150	1/0-300	2/0-300
175	UQFB-175	UQFBH-175	UQFB-175-X1	UQFBH-M-175	1/0-300	2/0-300
200	UQFB-200	UQFBH-200	UQFB-200-X1	UQFBH-M-200	1/0-300	2/0-300

Notes

- **UL listed:** For use with 60°C or 75°C wire.
- **UQFP:** For parallel main circuit breaker applications.
- **UQFP-M:** For series main circuit breaker applications Split load tab features allow for feed-through capability.
- **UQFB:** (2) 1/0-300 lugs provided on load and line side (cable-in, cable-out).
- **UQFB3:** Three-pole available. Consult factory.
- **UQFB-X:** (2) 1/0-300 lugs provided on load side and (2) line bar bus connections on line side.
- **UQFB-M:** For series main circuit breaker applications. Split load tab features allow for feed-through capability.

Please consult serving utility for their requirements prior to ordering or installing, as specifications and approvals vary by utility, and may require local electrical inspector approval. All installations must be installed by a licensed electrician and must comply with all national and local codes, laws and regulations. Milbank reserves the right to make changes in specifications and features shown without notice or obligation.



QP (small frame) and QN (large frame) | 120/240 VAC

15–125 Amps Breaker

Plug-In Type | 1-inch Per Pole

Amps	Poles	10K AIC Plug-In	22K AIC Plug-In
15	Single	Q115	Q115H
15	Double	Q215	Q215H
20	Single	Q120	Q120H
20	Double	Q220	Q220H
25	Single	Q125	Q125H
25	Double	Q225	Q225H
30	Single	Q130	Q130H
30	Double	Q230	Q230H
35	Single	Q135	Q135H
35	Double	Q235	Q235H
40	Single	Q140	Q140H
40	Double	Q240	Q240H
50	Single	Q150	Q150H
50	Double	Q250	Q250H
60	Single	Q160	Q160H
60	Double	Q260	Q260H
70	Single	Q170	Q170H
70	Double	Q270	Q270H
80	Double	Q280	Q280H
90	Double	Q290	Q290H
100	Double	Q2100	Q2100H
125	Double	Q2125	Q2125H



QN2200H



QN2200RH



WBJ2200



Q250

200 Amps Frame | Plug-In | 10,000 AIC & 22,000 AIC | Two-Pole, Common Trip

Amps	10K AIC Plug-In	22K AIC Plug-In	Handle Location	Wire Range	
				CU	AL
150	QN2150	QN2150H	Left facing	#4-300	#4-300
200	QN2200	QN2200H	Left facing	#4-300	#4-300
150	QN2150R	QN2150RH	Right facing	#4-300	#4-300
200	QN2200R	QN2200RH	Right facing	#4-300	#4-300
150	WBJ2150	—	Centered	#2-300	#2-300
200	WBJ2200	—	Centered	#2-300	#2-300

Notes

- Load connectors supplied with breakers.
- UL Listed for use with 60°C or 75°C wire.
- Wire sizes shown are lug capacity. Consult NEC Article #310 for specific wire sizes.



Please consult serving utility for their requirements prior to ordering or installing, as specifications and approvals vary by utility, and may require local electrical inspector approval. All installations must be installed by a licensed electrician and must comply with all national and local codes, laws and regulations. Milbank reserves the right to make changes in specifications and features shown without notice or obligation.

Hubs and Closing Plates

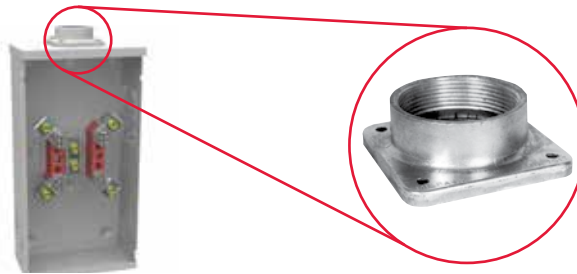
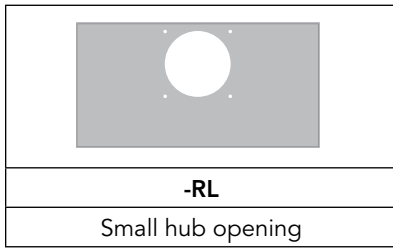

-WL A7514	-YL A7515	-ZL A7516	-DL A7517	-EL A7518	-XL A7551
1" hub	1¼" hub	1½" hub	2" hub	2½" hub	Small closing plate

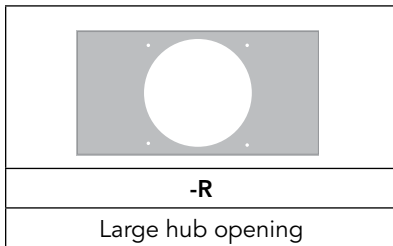

-F A8110	-G A8111	-H A8112	-X A9064	-RRL S8324
3" hub	3½" hub	4" hub	Large closing plate	Large hub opening adapted to small hub opening

Notes



- **Suffix:** Add to catalog number for factory installation of hub.
- **Packaging:** Individually packed units for field installation.
- **Abbreviations:** H.O. (hub opening), C.P. (closing plate).
- Hub Mast rated

Please consult serving utility for their requirements prior to ordering or installing, as specifications and approvals vary by utility, and may require local electrical inspector approval. All installations must be installed by a licensed electrician and must comply with all national and local codes, laws and regulations. Milbank reserves the right to make changes in specifications and features shown without notice or obligation.



Connector Kits, Closing Kits & Generator Interlock

Connector Kits — For Use with 3/8"-16 Studs Type Units Only

					
Single			Twin		
Suffix	Part #	(3 per set) - 1Ø	Suffix	Part #	(3 per set) - 1Ø
K1	K1539	6-350	K2	K1350	6-350
K3	K1540	4-600 or (2) 1/0-250*	K2L	K1350L	6-350 (non rotating)
K3L	K1540L	4-600 or (2) 1/0-250* (non rotating)	K4	K1541	4-600
Suffix	Part #	(4 per set) - 3Ø	Suffix	Part #	(4 per set) - 3Ø
K5	K3082	6-350	K6	K3442	6-350
K7	K3441	4-600 or (2) 1/0-250*	K8	K3083	4-600

*For (2) 1/0-250, conductors must be of same size.

Bypass Link





K8180 (sold in pairs)

Note

Consult factory for proper connector kits for studded meter sockets.

Closing Covers

	
Meter Closing Plate (Ring Type / Ringless)	Metal Closing Plate (For Ringless Sockets)
6003 - Gray Plastic	CP-21
6116 - Clear Plastic	
6002 - Clear Plastic with meter tabs	

Disconnect Sleeve



M5-144

Do not use with lever bypass sockets

Isolated Neutral Kit



K1047

Pole Hanger Kit

850 comes with 4 pole hangers

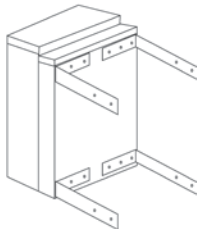
	
Catalog Number	Description of pole hanger brackets
850	Two pair (4 pieces) with mounting hardware

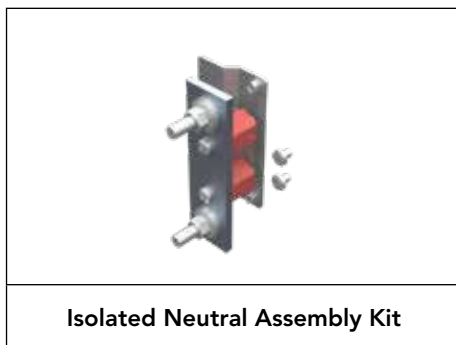





Isolated Neutral Assembly Kit

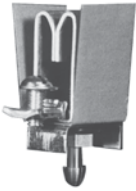

Please consult serving utility for their requirements prior to ordering or installing, as specifications and approvals vary by utility, and may require local electrical inspector approval. All installations must be installed by a licensed electrician and must comply with all national and local codes, laws and regulations. Milbank reserves the right to make changes in specifications and features shown without notice or obligation.

Fifth Terminals, Tap Connectors & Block Assemblies

Fifth Terminals

			
5T8K2 - 100-200 Amps "Plug-In"	K5T - 200 Amps (Block with Square Hole)	K3865 - Heavy Duty Jaw Clamping (K3866 without Neutral Wire)	K3356

Tap Connectors (3 per set)

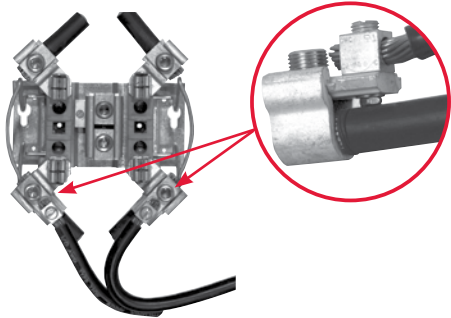
	Replaces the load or line side slide-in nut assembly on Milbank 200 Amps sockets. Allows for a 100 Amps tap location in addition to the #6-350 kcmil load-side connector. K5022 includes safety barrier extensions for applications over 300 VAC. Three lugs per kit.
K4977-INT - Internal Hex	
K4977-EXT - External Hex	
K5022-INT - Internal Hex (set of 4 w/ barrier)	

Triplex Ground

K1190 (For factory installed triplex ground, add suffix -TG to catalog number)

100 Amps Blocks *(single sockets only)*

BL7474 - Block Assembly
Z904486-AO - Slotted Nut Assembly
Z802965-AC - Neutral without Nut
Z901925-AC - Hex Nut Set Screw

200 Amps Blocks *(single sockets only)*



Please consult serving utility for their requirements prior to ordering or installing, as specifications and approvals vary by utility, and may require local electrical inspector approval. All installations must be installed by a licensed electrician and must comply with all national and local codes, laws and regulations. Milbank reserves the right to make changes in specifications and features shown without notice or obligation.



Multi-Position Tap Box

Three Phase



Features

- Painted aluminum construction: Enclosure shells are constructed with lightweight aluminum, making wall-mount installations easier. Powder-coat paint finish helps prevent corrosion.
- Capable of wall or pad mounting: Units feature a removable bottom, allowing an easy conversion from a wall-mount to a pad-mount.
- Smaller footprint: The UAP6094 model has a more compact footprint compared with the leading competitor.
- Multi-port ground lugs
- Optional penta bolt secured handle: Enclosure handle includes a penta bolt locking mechanism (see photos below) for enhanced protection. Does not come standard.



Optional (not standard)

Common Applications



Catalog Number	Phase	Position Lugs	Maximum Wire Size	Maximum Amps	Dimensions		
					D"	W"	H"
UAP6094-O	3	16	500 kcmil	3000 Amps	16	25 ⁵ / ₈	43
UAP6095-O	3	22	500 kcmil	4000 Amps	16	32 ³ / ₈	43
UAP6096-O	3	14	750 kcmil	3300 Amps	16	25 ¹ / ₁₆	51

Stainless steel pad mount spacing brackets included



Please consult serving utility for their requirements prior to ordering or installing, as specifications and approvals vary by utility, and may require local electrical inspector approval. All installations must be installed by a licensed electrician and must comply with all national and local codes, laws and regulations. Milbank reserves the right to make changes in specifications and features shown without notice or obligation.

Enclosed Controls

Attractive | Easy to Install | Secure | Cost-Effective

Milbank Enclosed Controls are pad-mounted, weather resistant electrical enclosures consisting of a utility pull section with optional meter socket, and a customer section containing distribution and control equipment. Commercial pedestals are an attractive, secure, easy to install and cost-effective solution when underground remote site power distribution and control equipment is required, replacing unsightly and inefficient strut and backboard structures.



Strut and backboard



Commercial pedestal

UL Listed as Industrial Control Equipment (File E113855)

Standard Features

- NEMA 3R weather resistant, vandal-resistant cabinet of polyurethane powder coated steel (aluminum or stainless steel also available)
- UL listed as enclosed industrial control equipment (UL508A)
- Isolated lockable and sealable utility metering and lug landing sections
- Lockable customer section for distribution and control equipment with internal deadfront
- Print pocket inside customer section door contains wiring schematics and installation instructions
- Load centers are UL listed for use with various manufacturers' circuit breakers
- All stainless steel external hardware (screws, bolts, hinges, handles, hasps and sealing screws)



Please consult serving utility for their requirements prior to ordering or installing, as specifications and approvals vary by utility, and may require local electrical inspector approval. All installations must be installed by a licensed electrician and must comply with all national and local codes, laws and regulations. Milbank reserves the right to make changes in specifications and features shown without notice or obligation.



Attractive | Easy to Install | Secure | Cost-Effective



Applications

These units are ideal for controlling and metering:

- Traffic signals
- Street lighting
- Power distribution for electronic vehicle charging stations
- Communication equipment such as cell towers and telephone vaults
- Event power for fairgrounds, swap meets, outdoor markets, portable offices, holiday lights, etc.
- Outdoor lighting for athletic fields, tennis and basketball courts, parking lots, landscaping and subdivision entrances, etc.

Available Factory-Installed Options

- Meter sockets: ring type or ringless, up to 400 Amps
- Main and branch breakers or T fuses
- Distribution: copper load centers and panelboards
- Clocks, timers and relays
- Photoelectric cells and controls
- Various power receptacles: pin and sleeve, twist lock or straight blade
- Contactors: lighting, definite purpose, motor starters
- Surge protection and lightning arrestors
- Generator inlets with interlocked breakers
- Push button controls
- Thermostat controls, fans and heating strips
- Power blocks and terminal blocks
- Steel, aluminum and plywood backboards
- Transformers
- Interlock devices for circuit breakers

Options

- Available in steel, aluminum (raw painted or anodized) or stainless steel construction with powder coated finish available in eight standard colors or special-ordered RAL colors
- Available for applications up to 400 Amps, 120V, 208V, 240V, 277V, 480V - 1Ø or 3Ø

Accessories

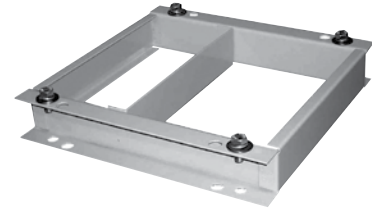

Padmount bases available for all pedestal sizes, inquire with your representative for details

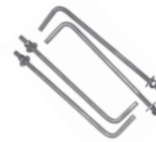

CP-ABK5/8

Anchor bolt kit
(includes four 5/8 - 13
x 18" anchor bolts)



105J

Fifth terminal kit for
use with ring type
meter sockets



K3865

Fifth terminal kit for
use with ringless
meter sockets



CP-TC7D

7-day time clock kit

CP-TC24H

24-hour time clock kit

CP-TCWIRE

Male 4-pin connector
and wiring harness for
use with time clocks
other than above

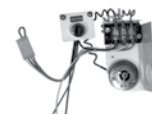

CP-PE-HOA-3POS

HOA switch for field
installation



Please consult serving utility for their requirements prior to ordering or installing, as specifications and approvals vary by utility, and may require local electrical inspector approval. All installations must be installed by a licensed electrician and must comply with all national and local codes, laws and regulations. Milbank reserves the right to make changes in specifications and features shown without notice or obligation.

Main Load Center Commercial Pedestals

Main Load Center Commercial Pedestal

1Ø3 wire 120/240V or 208Y/120V

Application: remote site service for multiple loads

Milbank Main Load Center Commercial Pedestals are designed to handle the vast majority of all requirements in a standard, stocked configuration.

- All units feature a load center with a plug-on, back-fed main breaker.
- Standard units are equipped with with a 16 circuit load center in the 100 Amps or 24 circuit load center in 200 Amps models
- Sub-feed lugs to allow feeding an external panel.

If your application requires turning loads on based on “dusk-to-dawn” requirements, be sure to see the Milbank Switched Load Center Commercial Pedestal products on the following page.

Features

These units include everything required for remote site service:

- Expandable: load centers allow for future expansion without costly modifications.
- All units feature a 200 Amps meter socket with optional field-installable fifth terminal kit available.
- 22K Amps interrupting capacity (AIC) standard.
- Optional mounting base can be embedded in concrete for fast, easy installation.
- Separate sealable and lockable utility termination section.
- Separate sealable and lockable metering section.
- Separate sealable and lockable customer section with a load center for “always on” loads that include a main circuit breaker, 20 (125 or 200 Amps model) or 14 (100 Amps model) blank breaker spaces and a circuit directory to document configuration.



Please consult serving utility for their requirements prior to ordering or installing, as specifications and approvals vary by utility, and may require local electrical inspector approval. All installations must be installed by a licensed electrician and must comply with all national and local codes, laws and regulations. Milbank reserves the right to make changes in specifications and features shown without notice or obligation.



Switched Load Center Commercial Pedestals

1Ø3 wire 120/240V or 208Y/120V

Designed not only to provide power for various loads, but also to switch specific loads on and off under certain conditions. A photoelectric cell is used for these controlled loads, and an optional time clock is also available.

Features

These units include everything required for remote site service:

- Expandable: load centers allow for future expansion without costly modifications.
- All units feature a 200 Amps meter socket with optional field-installable fifth terminal kit available.
- 22K Amps interrupting capacity (AIC) standard.
- Optional mounting base can be embedded in concrete for fast, easy installation.
- Separate sealable and lockable utility termination section.
- Separate sealable and lockable metering section.
- Separate sealable and lockable customer section with a control circuit including PE receptacle, Lexan® window, glare shield, Hand-Off-Auto (HOA) switch, contractor controlling a 16-circuit load center for controlled loads, a pre-mounted DIN rail and pre-wired connector to add an optional "plug-and-play" time clock kit for PE on and TC off operation and a circuit directory to document configuration.
- A load center for "always on" loads that includes a main circuit breaker, a control power circuit breaker, a switched load center main breaker, nine (125 or 200 Amps model) or 11 (100 Amps model) blank breaker spaces and a circuit directory to document configuration.



Ringless Lever Bypass shown

Applications



Traffic Signals



Parking Lots



Highways

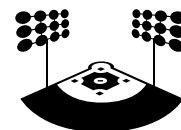

Athletic Field Lighting



Please consult serving utility for their requirements prior to ordering or installing, as specifications and approvals vary by utility, and may require local electrical inspector approval. All installations must be installed by a licensed electrician and must comply with all national and local codes, laws and regulations. Milbank reserves the right to make changes in specifications and features shown without notice or obligation.

Enclosed Controls

400 Amps Commercial Pedestals

67



Designed to provide a weather and vandal resistant metered enclosure for various loads and distribution. Each pedestal has been designed to handle a wide range of applications using standard, stocked configurations.

- Choice of a single main breaker or twin service disconnect breakers gives flexibility to the pedestal design.
- Optional distribution with feed-through lugs below the service disconnect breakers allows the pedestal to handle numerous applications.
- Typical applications include remote homes where the metering is best located at the curb side or other remote area. The pedestal can also provide power to secondary residence, on-site business, workshop, irrigation, lighting, security or other secondary load.
- Refer to page 18 for color options

Features

These units include everything required for remote service:

- Main circuit breaker or dual service disconnects
- Expandable: load center units allow for future expansion without costly modifications
- Optional mounting base can be embedded in concrete for fast, easy installation
- Separate sealable and lockable utility termination section with lug termination
- Separate sealable and lockable metering section
- A separate sealable and lockable customer section with a circuit directory and a print pocket to hold all documentation
- Meter socket options include ring type with bypass studs, ringless with heavy duty lever bypass, or K-Type bolt-on

Applications

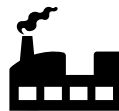

Commercial Job Sites



Remote Site for
Residential &
Commercial Job Sites

Please consult serving utility for their requirements prior to ordering or installing, as specifications and approvals vary by utility, and may require local electrical inspector approval. All installations must be installed by a licensed electrician and must comply with all national and local codes, laws and regulations. Milbank reserves the right to make changes in specifications and features shown without notice or obligation.



Surface-Mount Commercial Pedestal

Originally developed for small cellular communications, the surface-mount enclosed control offers the flexibility of larger enclosed controls products with a smaller footprint and several mounting options.

**NEW
PRODUCT!**



Features

- Easy installation
- Overhead and underground entry and exit, all in one unit
- Meter and components in one enclosure
- UL508A & UL891
 - Custom component configurations
 - UL listing covers all internal components
- Can be mounted on multiple surfaces
 - Walls
 - Poles – narrow profile will have minimal extension past sides
 - H Frames (Strut)
- Multiple bypass options available
- Monitoring options available
- Can be powder coated in any Milbank standard EC colors or custom colors.



Benefits

- Does not take up sidewalk space
- Flood resistant
- Eliminates need for connecting components - Wire in - Wire Out

Applications



Communications
Power
Distribution



Lighting
Control

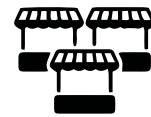

Streetscape
Power
Distribution



Please consult serving utility for their requirements prior to ordering or installing, as specifications and approvals vary by utility, and may require local electrical inspector approval. All installations must be installed by a licensed electrician and must comply with all national and local codes, laws and regulations. Milbank reserves the right to make changes in specifications and features shown without notice or obligation.

Enclosed Controls

Battery Backup Commercial Pedestals



Designed to provide battery backup power for various loads, and to switch specific loads on and off under certain conditions; a photoelectric cell or time clock to control lighting circuits, as an example. Metered and unmetered power distribution options are available. The back-up power pedestal is designed to handle the vast majority of today's back-up power requirements. By using a 19" rack design, shelves can be adjusted to accommodate the required batteries and manufactures DC to AC inverters, transfer switches and other related equipment. This design gives the user a wide range of design and configuration options. Complete turnkey, ready to power-up pedestals are offered along with basic units ready to accept batteries and inverters supplied by others.

Features

- 100 through 320 Amps meter socket with the option of either a ring type socket (conforms to EUSERC 308) with or without test/bypass blocks or a heavy duty ringless socket with lever bypass
- Separate sealable utility termination compartment
- An isolated separate customer section with service disconnects, power distribution options and power control
- 19" wide rack in customer compartment for easy layout of equipment
- Battery trays
- Thermostat with cooling fan
- Filtered louvers for heat rise flow through ventilation
- Three point door latch (key or pad lockable)

Note

- May require customization based on regional requirements

Applications



Traffic Signals



Communications
Power Distribution



Parking Lots



Camera & Security
Locations

Options

- Manual bypass switch
- Transfer switch for generator power back-up
- Generator inlet receptacles 30 Amps through 200 Amps
- Pad lockable provision for receptacles
- Police access door
- Metered load center distribution
- Unmetered load center distribution
- Photo electric controls (for street lighting)
- Time clocks
- HOA switches
- Contactors
- GFCI duplex receptacles
- Thermostat for heating control
- Heating pads or elements
- Roll out shelves for batteries
- Surge arrestors and lighting arrestors

Please consult serving utility for their requirements prior to ordering or installing, as specifications and approvals vary by utility, and may require local electrical inspector approval. All installations must be installed by a licensed electrician and must comply with all national and local codes, laws and regulations. Milbank reserves the right to make changes in specifications and features shown without notice or obligation.





Providing metered or unmetered AC power, distribution, surge suppression, mechanical interlock and stand-by generator receptacle — all in a neat, compact pedestal.

Features

- 120/240V 1Ø3W through 277/480V 3Ø4W ratings
- Metered or unmetered units
- Choice of EUSERC ring type or ringless meter sockets
- 60 Amps through 400 Amps ratings
- Pad lockable, isolated utility compartments
- 20 Amps GFCI convenience receptacle
- Lockable recessed generator receptacle door
- Utility and generator indicator light options
- All stainless steel hardware
- Galvanized steel, aluminum or stainless steel cabinet options
- Custom designs available

Note

- May require customization based on regional requirements



Applications



Traffic Signals



Pump & Lift
Stations



Communications
Power Distribution



Please consult serving utility for their requirements prior to ordering or installing, as specifications and approvals vary by utility, and may require local electrical inspector approval. All installations must be installed by a licensed electrician and must comply with all national and local codes, laws and regulations. Milbank reserves the right to make changes in specifications and features shown without notice or obligation.

Enclosed Controls

CT Metered Commercial Pedestals



Designed to be used where a smaller service package would be a better choice over larger switchgear equipment, these pedestals have amperage ratings of 400 to 800 Amps at voltages up through 480 VAC three phase.

Features

- Up to 800 Amps
- A low profile CT pedestal
- All utility equipment is isolated in separated pad lockable and sealable compartments
- Separate customer compartment designed to hold distribution and control equipment
- Deadfront customer construction
- Optional mounting base
- Optional construction in steel, aluminum and stainless steel
- Wide choice of powder paint colors

Note

- May require customization based on regional requirements

Applications

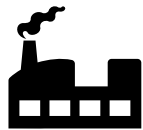

Commercial & Industrial Control Systems



Pump & Lift Stations



Water Treatment Plants

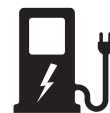

Electric Vehicle Charging Stations

Please consult serving utility for their requirements prior to ordering or installing, as specifications and approvals vary by utility, and may require local electrical inspector approval. All installations must be installed by a licensed electrician and must comply with all national and local codes, laws and regulations. Milbank reserves the right to make changes in specifications and features shown without notice or obligation.



Enclosed Controls

Slimline Commercial Pedestals



Provides a sleeker, smaller footprint, with wireway access on the side of the unit rather than the back, allowing maximum flexibility to place the pedestal anywhere physical space is at premium.

Providing unmetered AC power, distribution, surge suppression, mechanical interlock and stand-by generator receptacle — all in a neat, compact pedestal.

Features

- 100 or 200 Amps
 - Vandal-resistant, secure and attractive design
 - Customer compartment with distribution and control equipment with swing Deadfront door, secured with both a hasp/latch and draw latch outer door
 - Utility metering compartment protected with a hinged hood, increasing resistance to meter vandalism
 - Small footprint
 - Wireway located on left side of pedestal for utility incoming wire, allowing pedestal to be mounted with back as close as 14" to walls or structures
 - Available in 12" and 20" widths and 50" and 63" (metered) and 43" (unmetered) heights
 - Includes a print pocket for plans and drawings
 - Voltage range: 120V–480V
 - Compatible with both ringless and ring type meter sockets, 4–7 terminals
 - Available in a wide array of colors, including but not limited too all ANSI powder coated paint colors upon request
- Pedestal mounting base option saves time and labor to install on a cement pad—no anchor bolts required
 - Powder coated G90 galvanized steel or Aluminum; raw, anodized or powder coated, as well as stainless steel exterior options

Note

- May require customization based on regional requirements

Direct bury pedestals offer many advantages. With no need to coordinate, buy or wait for concrete, installation time can be cut down to less than an hour. Traditional direct bury pedestals are awkward to transport and handle and can only be used in a direct bury application. Milbank's modular design offers flexibility and convenience for distributors and contractors alike.

It's constructed with 14 guage steel and only available for 12" pedestals.



Water Treatment
Plants



Highways



Parks &
Landscaping



Please consult serving utility for their requirements prior to ordering or installing, as specifications and approvals vary by utility, and may require local electrical inspector approval. All installations must be installed by a licensed electrician and must comply with all national and local codes, laws and regulations. Milbank reserves the right to make changes in specifications and features shown without notice or obligation.



Milbank's Millennium Series includes both metered and unmetered surface-mount power outlets and metered and unmetered power outlet pedestals. These products are primarily used for Recreational Vehicle (RV) applications providing power for RVs. However, the Millennium Series can also provide versatility when it comes to power distribution and has been used for other applications besides RV parks. For example, if you need temporary power for construction or other temporary power applications such as event power (i.e., music events, festivals, etc.), consider the Millennium Series to fulfill your needs!

Features of the Millennium Series include:

- 125 Amps rating
- Ring type meter socket (ringless available upon request in most cases)
- 120/240 VAC rated
- Standard copper wiring on all receptacles and circuit breakers
- Locking provisions for both hinge cover and deadfront
- Pedestals are available for direct bury or pad-mount applications
- Pedestals come with options for both single and double powerheads

One benefit of the Millennium Series is that receptacles are attached to a stationary bridge rather than the deadfront, making them easy to take off and replace if ever needed. Because the receptacles are a standard configuration, it is also easy to find necessary replacements rather than searching for a specialized parts.

The Millennium Series is constructed from 16-gauge G90 galvanized steel and is housed in a NEMA 3R rated enclosure with a gray powder coat finish. They are also UL listed. As with all Milbank products, the Millennium Series is proudly manufactured in the United States.



Please consult serving utility for their requirements prior to ordering or installing, as specifications and approvals vary by utility, and may require local electrical inspector approval. All installations must be installed by a licensed electrician and must comply with all national and local codes, laws and regulations. Milbank reserves the right to make changes in specifications and features shown without notice or obligation.





NEMA Commercial Enclosures

Milbank's line of commercial enclosures includes the full gamut of styles and sizes; everything from junction boxes to transformer cabinets, telephone cabinets to wireway.

Type 1 Enclosures

Milbank's Type 1 enclosures are designed for indoor use to provide a degree of protection to personnel against access to hazardous parts and to provide a degree of protection of the equipment inside the enclosure against ingress of solid foreign objects, such as falling dirt.

Type 3R Enclosures

Milbank's Type 3R enclosures are designed for either indoor or outdoor use to provide a degree of protection from harmful effects on the equipment due to the ingress of water (rain, sleet, snow) and that will be undamaged by the external formation of ice on the enclosure.

Wireway

Milbank's wide range of wireway is available in many styles and sizes and its wide range of fittings allows it to smoothly transition to and from competitors' products.



Please consult serving utility for their requirements prior to ordering or installing, as specifications and approvals vary by utility, and may require local electrical inspector approval. All installations must be installed by a licensed electrician and must comply with all national and local codes, laws and regulations. Milbank reserves the right to make changes in specifications and features shown without notice or obligation.

Watt hour Meter Forms

Standard Forms | Transformer Rated or Self-Contained

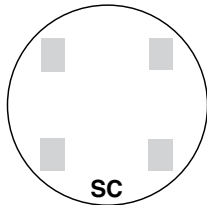

SC
2 and 3-WIRE FORMS
1S & 2S

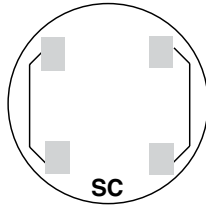

SC
2 and 3-WIRE FORMS
1S & 2S with BYPASS

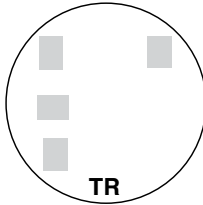

TR
2-WIRE FORM 3S
5th Term. 9 o'clock

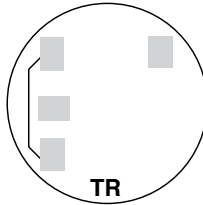

TR
2-WIRE FORM 3S
with BYPASS

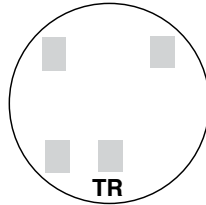

TR
2-WIRE FORM 3S
5th Term. 6 o'clock

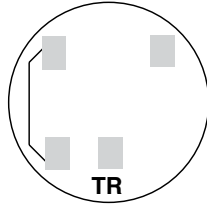

TR
2-WIRE FORM 3S
with BYPASS

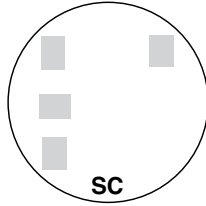

SC
2 ELEMENT
3-WIRE NETWORK
FORM 12S 5th
TERM. 9 o'clock

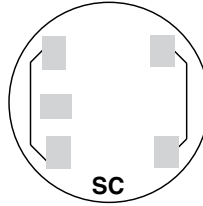

SC
2 ELEMENT 3-WIRE
NETWORK FORM 12S
with BYPASS
5th Term. 9 o'clock

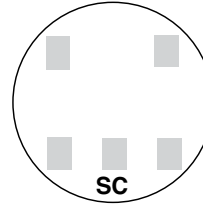

SC
2 ELEMENT
3-WIRE NETWORK
FORM 12S 5th
TERM. 6 o'clock

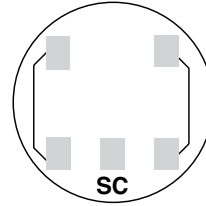

SC
2 ELEMENT 3-WIRE
NETWORK FORM 12S
with BYPASS
5th Term. 6 o'clock

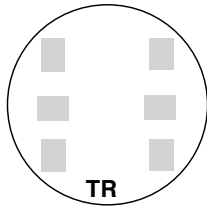

TR
3-WIRE FORM 4S

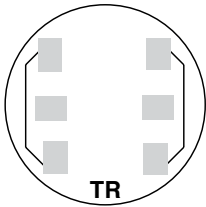

TR
3-WIRE FORM 4S
WITH BYPASS

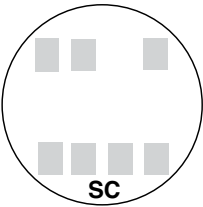

SC
2 or 3 ELEMENT
3Ø4W Y or Δ
Y FORM 14S
Δ FORM 15S

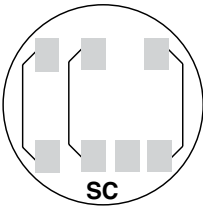

SC
2 or 3 ELEMENT
3Ø4W Y or Δ
FORMS 14S & 15S
with BYPASS

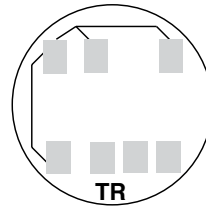

TR
2 ELEMENT
3Ø4W Y or Δ
Y FORM 7S
Δ FORM 24S
with BYPASS

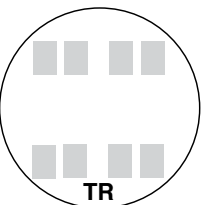

TR
2 ELEMENT
2Ø3W, 2Ø4W, 3Ø3W
FORM 5S

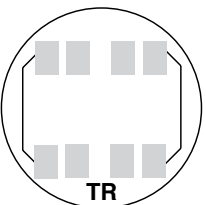

TR
2 ELEMENT 2Ø3W,
2Ø4W, 3Ø3W
FORM 5S with
BYPASS

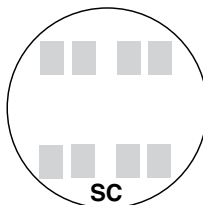

SC
2 ELEMENT
2Ø3W, 2Ø4W, 3Ø3W
FORM 13S

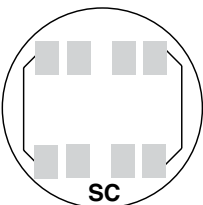

SC
2 or 3 ELEMENT
2Ø3W, 2Ø4W, 3Ø3W
FORM 13S with
BYPASS

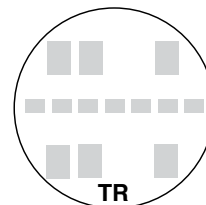

TR
2 or 3 ELEMENT
3Ø4W Y or Δ
Y FORM 9S
Δ FORM 8S

TR = TRANSFORMER RATED
SC = SELF CONTAINED

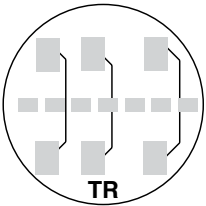

TR
2 or 3 ELEMENT
3Ø4W Y or Δ
FORMS 8S & 9S
with BYPASS

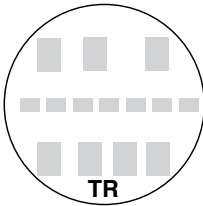

TR
2 ELEMENT
3Ø4W Y
FORM 6S

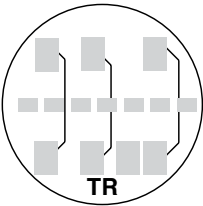

TR
2 ELEMENT
3Ø4W Y
FORM 6S
with BYPASS

Please consult serving utility for their requirements prior to ordering or installing, as specifications and approvals vary by utility, and may require local electrical inspector approval. All installations must be installed by a licensed electrician and must comply with all national and local codes, laws and regulations. Milbank reserves the right to make changes in specifications and features shown without notice or obligation.

DIAGRAM A
 1Ø2W with 1 P.T. & 1 C.T.
 Single Stator Meter(2W1Ø) - Form 3S
 5T Socket, Test Switch #TS04-0101

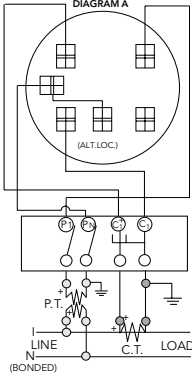

DIAGRAM B
 1Ø3W with 1 C.T.
 Single Stator Meter (2W1Ø) - Form 3S
 5T Socket, Test Switch #TS04-0101

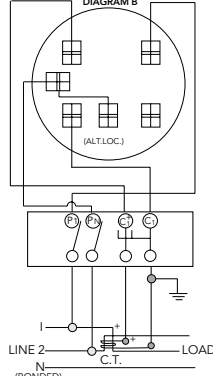

DIAGRAM C
 1Ø3W with 2 C.T.'s
 Single Stator Meter (3W1Ø) - Form 4S
 6T Socket, Test Switch #TS07-0105

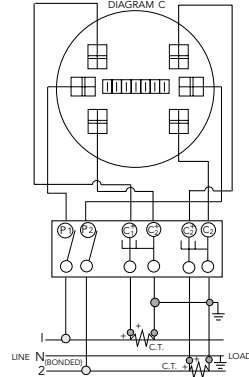

DIAGRAM D
 1Ø3W or 3W Network with 2 C.T.'s
 2 Stator Meter - Form 5S
 8T Socket, Test Switch #TS07-0105

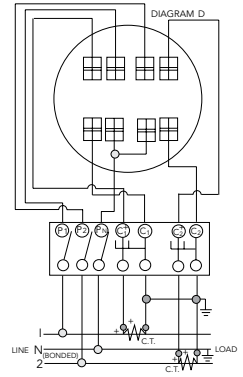

DIAGRAM E
 3Ø3W "A" with 2 P.T.'s & 2 C.T.'s
 2 Stator Meter - Form 5S
 8T Socket, Test Switch #TS07-0105

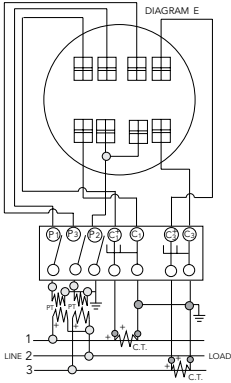

DIAGRAM F
 3Ø3W "A" with 2 C.T.'s
 2 Stator Meter - Form 5S
 8T Socket, Test Switch #TS07-0105

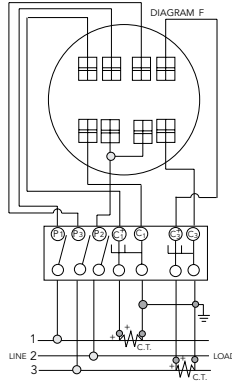

DIAGRAM G
 3Ø4W "Y" with 3 C.T.'s
 2 ½ Stator Meter - Form 6S
 13T Socket, Test Switch #TS10-0109

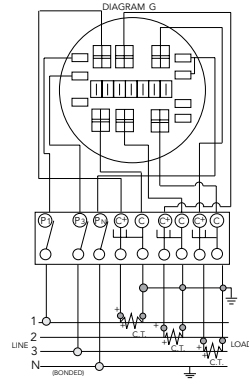

DIAGRAM H
 3Ø4W "Y" with 2 P.T.'s & 3 C.T.'s
 2 ½ Stator Meter - Form 6S
 13T Socket, Test Switch #TS10-0109

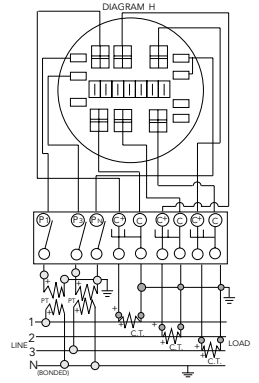

DIAGRAM I
 3Ø4W "Y" or "A" with 3 C.T.'s
 "Y" 3 Stator Meter - Form 9S
 "A" 2 Stator Meter - Form 8S
 13T Socket, Test Switch #TS10-0109

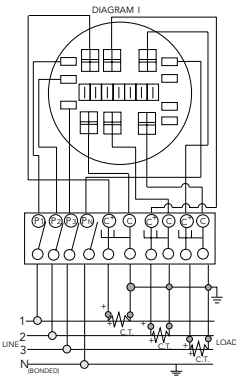
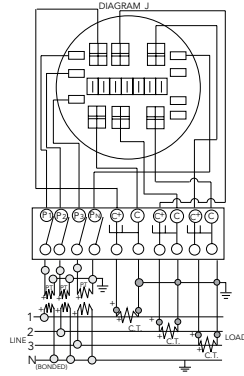

DIAGRAM J
 3Ø4W "Y" with 3 P.T.'s & 3 C.T.'s
 3 Stator Meter - Form 9S
 13T Socket, Test Switch #TS10-0109



Prewiring: If standard factory prewiring is required, refer to wiring diagrams on this page. Determine appropriate diagram and send a copy with order. If custom factory prewiring is required, specify on order. Be sure to include meter socket catalog number, test switch make and catalog number, meter form number and provide a copy of your wiring diagram.



Please consult serving utility for their requirements prior to ordering or installing, as specifications and approvals vary by utility, and may require local electrical inspector approval. All installations must be installed by a licensed electrician and must comply with all national and local codes, laws and regulations. Milbank reserves the right to make changes in specifications and features shown without notice or obligation.

Conduit, Ampacity & SCCR

Reference Information

MAXIMUM NUMBER OF CONDUCTORS IN CONDUIT

Table from 2008 NEC Code Reference: Rigid Metal Conduit

Type	Conductor Size (AWG/kcmil)	Conduit Trade Sizes (Inches)									
		3/8	1/2	3/4	1	1 1/4	1 1/2	2	2 1/2	3	3 1/2
THHN, THWN, THWN-2	12	9	16	26	46	62	102	146	225	301	387
	10	6	10	17	29	39	64	92	142	189	244
	8	3	6	9	16	22	37	53	82	109	140
	6	2	4	4	12	16	27	38	59	79	101
	4	1	2	4	7	10	16	23	36	48	62
	3	1	1	3	6	8	14	20	31	41	53
	2	1	1	3	5	7	11	19	26	34	44
	1	1	1	1	4	5	8	12	19	25	35
	1/0	1	1	1	3	4	7	10	16	21	27
	2/0	0	1	1	2	3	6	8	13	18	23
	3/0	0	1	1	1	3	5	7	11	15	19
XHH, XHHW, XHHW-2	4	1	2	4	7	10	16	24	37	49	63
	2	1	1	3	5	7	12	17	26	35	45
	1/0	1	1	1	3	4	7	10	16	22	28
	2/0	0	1	1	2	3	6	9	13	18	23
	4/0	0	1	1	1	2	4	6	9	12	16
	250	0	0	1	1	1	3	5	7	10	13
	350	0	0	1	1	1	2	3	6	7	10
	500	0	0	0	1	1	1	2	4	5	7
750	0	0	0	0	1	1	1	3	4	5	

This table is for concentric stranded conductors only. For cables with compact conductors refer to NEC. Refer to latest NEC Code or Local Codes for updated requirements.

*** ALLOWABLE AMPACITIES OF INSULATED COPPER & ALUMINUM CONDUCTORS (3W IN CONDUIT) 75° C (167° F)**

A		AL or **CU-Clad AL	
A	B	A	B
18	—	—	—
16	—	—	—
14	20†	—	—
12	25†	12	20†
10	35†	10	30†
8	50	8	40
6	65	6	50
4	85	4	65
3	100	3	75
2	115	2	90
1	130	1	100
1/0	150	1/0	120
2/0	175	2/0	135
3/0	200	3/0	155
4/0	230	4/0	180
250	255	250	205
300	285	300	230
350	310	350	250
400	335	400	270
500	380	500	310
600	420	600	340
700	460	700	375
750	475	750	385

A = Size: AWG/MCM
 *B = Ampere Rating for Insulation Types: FEPW, RH, RHW, THW, THWN, XHHW, USE, 2W.
 **C = Ampere Rating for Insulation Types: RH, RHW, THW, THWN, XHHW, USE (Per NEC table 310-16)
 Overall ampere ratings of U/L listed Milbank multiple position meter sockets are based on 2008 N.E.C. Handbook Article 220-84 and ANSI / UL-414 (except where restricted by line connector size.) These requirements provide for a diversity factor / demand factor being utilized in determining the overall (main bus / lug) rating of a gang socket. All Milbank U/L listed gang sockets meet or exceed these diversity factor / demand and factor requirements. Standard overall ampacity ratings for U/L listed and non U/L listed gang sockets are as shown in the chart below. Ampere ratings of meter sockets are based on the meter socket being wired with 75° C insulated wire conductor, sized in accordance with Table 310-16 of the National Electric Code.

AMPACITY CORRECTION FACTORS

Ambient Temp. C°	Correction Factor	Ambient Temp. F°
21 - 25	1.05	70 - 77
25 - 30	1.00	78 - 86
31 - 35	.94	87 - 95
36 - 40	.88	96 - 104
41 - 45	.82	105 - 113
46 - 50	.75	114 - 122
51 - 55	.67	123 - 131
56 - 60	.58	132 - 140
61 - 65	.33	141 - 158

GANG SOCKET OVERALL AMPACITIES

# of Meter Pos.	100A/Pos. Ampacity	125A/Pos. Ampacity	150A/Pos. Ampacity	200A/Pos. Ampacity
2	200A	200A	200A	200A #
3	200A	225A	225A	270A
4	200A	250A	270A	360A
5	225A	285A	338A	450A
6	270A	330A	396A	528A

† Unless otherwise permitted elsewhere in the Code, the overcurrent protection for conductor types marked with an obelisk (†) shall not exceed 15 amps for 14 AWG, 20 amps for 12 AWG, and 30 amps for 10 AWG copper: or 15 amps for 12 AWG aluminum and 25 amps for 10 AWG aluminum and copper-clad aluminum after any correction factors for ambient temperature and number of conductors have been applied.

Some constructions are rated at 400 amps overall (1252). Contact your sales representative for more information. Refer to latest NEC Code or Local Codes for updated requirements.

Please consult serving utility for their requirements prior to ordering or installing, as specifications and approvals vary by utility, and may require local electrical inspector approval. All installations must be installed by a licensed electrician and must comply with all national and local codes, laws and regulations. Milbank reserves the right to make changes in specifications and features shown without notice or obligation.



Important Note

In addition to national and local electrical codes, many utilities have specific requirements for metering equipment. Always consult the serving utility for their specifications and requirements prior to ordering or installing Milbank meter mounting equipment.

Before Energizing

1. Give equipment a thorough visual examination to determine that:
 - A. No shipping or installation damage exists.
 - B. Proper clearances have been maintained.
 - C. All connections have been made.
 - D. Equipment is clean and dry.
2. Make a thorough examination to:
 - A. Verify tightness of all bolted connections (see table below).
 - B. Manually operate all circuit breakers, switches, relays, etc.
 - C. Check rigidity of all mountings, bus bars and components.
 - D. Use test equipment to check continuity of circuitry and integrity of insulation.
3. All switches and circuit breakers should be in the "off" position.
4. Verify that manual meter bypass (if applicable) is in non-bypass position.
5. Install cover and/or close doors.
6. If installation is not being energized at this time, follow "after-energizing" steps listed below. These steps will secure the installation in case of accidental energization.

When Energizing

Use caution and follow established safety procedures:

- 1) Wear safety apparel.
- 2) Use safety equipment.
- 3) Take action to prevent injury to yourself and others in the event of failure of the installation.
- 4) Take action to prevent/decrease damage to property in the event of failure of the installation.
- 5) If you are unsure how to safely energize the installation, get someone who is knowledgeable to do it.

After Energizing

Secure the installation:

- 1) To prevent accidental contact with energized parts, cover all openings with approved filler devices.
- 2) To prevent unauthorized access, secure all covers and/or doors with approved security devices.
- 3) Attach/post information to advise others of potential hazards associated with the installation.

Recommended Torque for General Applications*

Nominal Size	Joint Description		Head Type	Torque (Inch Lbs.)
	Screw	Nut		
10	Brass	Brass Nut or Extruded Hole	All	20-25 inch lbs.
10	Steel	Copper or Aluminum Busbar \leq 1/8"	All	25-30 inch lbs.
10	Steel	Steel Nut or Extruded Hole; CU or AL Busbar $>$ 1/8"	All	30-35 inch lbs.
12	Steel	Aluminum Extruded Hole	All	30-35 inch lbs.
12	Steel	Steel Nut or Extruded Hole	All	40-50 inch lbs.
1/4	Steel	Aluminum Extruded Hole	All	40-50 inch lbs.
1/4	Steel	Steel Nut or Extruded Hole; CU or AL Busbar	All	50-60 inch lbs.
5/16	Steel	Aluminum Extruded Hole	Hex	60-70 inch lbs.
5/16	Steel	Steel Nut or Extruded Hole; CU or AL Busbar	Hex	100-150 inch lbs.
3/8	Steel	Steel Nut	Hex	150-200 inch lbs.
1/2	Steel	Steel Nut	Hex	200-250 inch lbs.

* Interior labels typically indicate the required torque for wire connectors and studs, and should be referenced first.
CU: Copper
AL: Aluminum



Please consult serving utility for their requirements prior to ordering or installing, as specifications and approvals vary by utility, and may require local electrical inspector approval. All installations must be installed by a licensed electrician and must comply with all national and local codes, laws and regulations. Milbank reserves the right to make changes in specifications and features shown without notice or obligation.

Materials

Steel Quality

The meter equipment listed in this catalog is made of galvanized steel (AISI* G90) to afford the best possible weather proofing.
*American Iron and Steel Institute.

Steel Sheet

16 gauge, galvanized, sheet: 1 1/4 oz./ sq.ft. class zinc-coated. (AISI G90)
14 gauge, galvanized, sheet: 1 1/4 oz./ sq.ft. class zinc-coated.

Aluminum Extrusion

Wire-Terminals: Alloy; 6061-T6, Tin-plated for Cu/Al wire.
Bus Bar: Alloy; 6101-O & 6063-O

Aluminum Sheet

3000 series aluminum sheet, H14, or 5052 series aluminum sheet, H32. Where applicable thicknesses range from .064-.125

Copper Sheet & Bus

Electrolytic copper with tin plating in most applications.

Insulating Materials

- In most units, support bases for current-carrying components are molded from fiberglass reinforced high-strength, track resistant, thermoset polyester molding compounds.
- Clear or black safety shields and polarity barriers are molded from high-strength, track resistant, polycarbonate molding compounds.
- Various sheet insulating materials, as appropriate for the application are utilized in the fabrication of flat, formed and punched component parts and barriers.

Finish

Process

Light gray state-of-the-art electrostatically applied powder paint offers a durable, non-fading finish. For further information concerning the chemical analysis of the weather resistant finish, please contact the factory.

Metal Fasteners

Zinc-coated with a chromate dip.

Ratings & Compliance

Ratings & Compliance

All Milbank electrical enclosures in this catalog are rated "Type 3R Enclosure" unless specified otherwise on the product's page. All enclosures with a UL designation are constructed per the appropriate UL Standard and may be installed per the National Electric Code. UL procedure files associated with the UL Standards are listed as follows: Meter Sockets (UL 414, File E30202), Test Switches (UL 414, File E62531), Power Outlets (UL 231, File E90945), Panelboards (UL 67, File E32628) and Pullout Switches (UL 1429, File E133062). Additional standards are utilized as applicable: Meter Sockets (ANSI C12.7), Test Switches (ANSI C12.9) and Panelboards (NEMA PB-1).

Please consult serving utility for their requirements prior to ordering or installing, as specifications and approvals vary by utility, and may require local electrical inspector approval. All installations must be installed by a licensed electrician and must comply with all national and local codes, laws and regulations. Milbank reserves the right to make changes in specifications and features shown without notice or obligation.



U3802.....	6	U3995-XL-200*.....	23	U2874-XT-5T9.....	35
U3812.....	6	U5750-RXL-200-BL.....	23	U2875-XT-5T9.....	35
U3832.....	6	U6281-XL-200.....	23	U2876-XT-5T9.....	35
U3862.....	6	U4031-O-2/200.....	24	U2732-XT.....	36
U3822-20GWR.....	7	U4835-X-2/200-BL.....	24	U2733-XT.....	36
U4881-O-50GB.....	8	U6584-O-2/200-BL.....	25	U2734-XT.....	36
U4881-O-60GB.....	8	U6589-X-2/200 BL.....	25	U2735-XT.....	36
U5934-XL-BLG.....	9	U6115-X-2/200-K7L-BL.....	26	U2736-XT.....	36
U7487-O-TG.....	10	U6227-X-400-K3-BL.....	26	U6123-X-BL.....	37
U7487-RL-TG.....	10	U6228-X-400-K3-BL.....	26	U6124-X-BL.....	37
U7487-YL-TG.....	10	U6229-X-400-K7-BL.....	26	U6125-X-BL.....	37
U7021-RL-TG.....	11	U6230-X-400-K7-BL.....	26	U2288-RXL.....	38
U7040-O-TG.....	11	U5767-X-200-CB-BL.....	27	U2852-X.....	38
U7040-XL-TG.....	11	U5787-O-200-CB.....	27	U2853-X.....	38
U1980-O.....	12	U5796-X-400-CB-BL.....	27	U2854-X.....	38
U4413-O-BL.....	12	U5799-O-400-CB-BL.....	27	U2855-X.....	38
U5777-O.....	12	U1780-O.....	28	U2856-X.....	38
U2272-RL-5T9-BL.....	13	U2264-XL.....	28	U2862-X.....	38
U2860-XL-5T9-QG.....	13	U2692-XL.....	28	U2863-X.....	38
U7573-RL.....	13	U2693-XL.....	28	U2864-X.....	38
U9318-RL.....	14	U7362-DL.....	29	U2865-X.....	38
U9319-XL.....	14	U7363-DL.....	29	U2866-X.....	38
U3924-XL.....	15	U7364-DL.....	29	U5902-X-BL.....	40
U4721-O-BL.....	15	U7365-DL.....	29	U5903-X-BL.....	40
U9800-RRL-QG-BL-NE.....	15	U7366-DL.....	29	U5904-X-BL.....	40
U9801-RXL-QG.....	15	U2601-XL.....	30	U5905-X-BL.....	40
U9550-RRL-QG.....	16	U8212-XL.....	30	U5906-X-BL.....	40
U9551-RXL-QG.....	16	U8213-XL.....	30	U5882-X-BL.....	41
U4910-O-BL.....	17	U8214-XL.....	30	U5883-X-BL.....	41
U9700-RRL-QG-BL.....	17	U8215-XL.....	30	U5884-X-BL.....	41
U9701-RXL-QG.....	17	U8216-XL.....	30	U5885-X-BL.....	41
U2448-X.....	18	U1252-X-K1.....	31	U5886-X-BL.....	41
U4778-X-BL.....	18	U1253-X-K3.....	31	U4372-XT-5T9.....	43
U2594-X.....	19	U1254-X-K3.....	31	U4373-XT-5T9.....	43
U4611-X.....	19	U1255-X-K4.....	31	U4374-XT-5T9.....	43
U4911-X-BL.....	19	U1256-X-K4.....	31	U4375-XT-5T9.....	43
U3499-XL.....	20	U3763-XL.....	32	U4376-XT-5T9.....	43
U3499-XL-100.....	20	U3764-XL.....	32	U5972-XT-5T9-BL.....	44
U3798-O-200.....	20	U3765-XL.....	32	U5973-XT-5T9-BL.....	44
U3741-XL-100-BL.....	21	U5112-X-5T9-BL.....	33	U5974-XT-5T9-BL.....	44
U3791N-RXL-200-BL.....	21	U5113-X-5T9-BL.....	33	U5975-XT-5T9-BL.....	44
U5140-RXL-200-BL.....	21	U2752-X-5T9.....	34	U5976-XT-5T9-BL.....	44
U5168-XL-100-BL-NE.....	22	U2753-X-5T9.....	34	UC1299-XL.....	46
U5168-XL-200-BL-NE.....	22	U2754-X-5T9.....	34	UC7544-RL.....	46
U5898-O-200.....	22	U2755-X-5T9.....	34	UC7545-RL.....	46
U3771-XL-100-BL.....	23	U2756-X-5T9.....	34	UC7448-XL.....	47
		U2872-XT-5T9.....	35	UC7449-XL.....	47
		U2873-XT-5T9.....	35	UC7532-XL.....	47



Please consult serving utility for their requirements prior to ordering or installing, as specifications and approvals vary by utility, and may require local electrical inspector approval. All installations must be installed by a licensed electrician and must comply with all national and local codes, laws and regulations. Milbank reserves the right to make changes in specifications and features shown without notice or obligation.

Index

UC4964-O-WC-21-NST	48	UQFBH-150	57	Q290.....	58
UC4965-O-WC-21-NST	48	UQFBH-175	57	QN2150.....	58
UC4966-O-WC-21-NST	48	UQFBH-200	57	QN2150R.....	58
UC7444-O-141-NOE	48	UQFBH-M-100.....	57	QN2200.....	58
UC7445-O-311-NOE	48	UQFBH-M-125.....	57	QN2200R.....	58
UC7478-O-81-NOE	48	UQFBH-M-150.....	57	WBJ2150	58
TS04-0101	49	UQFBH-M-175.....	57	WBJ2200	58
TS04-0102	49	UQFBH-M-200.....	57	A7514	59
TS04-0103	49	UQFP-100.....	57	A7515	59
TS04-0104	49	UQFP-125.....	57	A7516	59
TS07-0018	49	UQFP-150.....	57	A7518	59
TS07-0022	49	UQFP-175.....	57	A7551	59
TS07-0049	49	UQFP-200.....	57	A8110	59
TS07-0059	49	UQFPH-100	57	A8111	59
TS10-0109	49	UQFPH-125	57	A8112	59
TS10-0110	49	UQFPH-150	57	A9064	59
TS10-0111	49	UQFPH-175	57	S8324.....	59
TS10-0112	49	UQFPH-200	57	850.....	60
U1855-O-NE.....	50	UQFPH-M-100.....	57	K1047	60
U1856-O-NE.....	50	UQFPH-M-125.....	57	K1350	60
U6568-O-NE.....	50	UQFPH-M-150.....	57	K1350L	60
S1857.....	51	UQFPH-M-175.....	57	K1539	60
S2718-FB-XL-C	52	UQFPH-M-200.....	57	K1540	60
S3390-FB-XL-C7	52	UQFP-M-100	57	K1540L	60
S3176-O	53	UQFP-M-125	57	K1541	60
S4098-O	53	UQFP-M-150	57	K3082	60
U5136-O-200S-NHB.....	54	UQFP-M-175	57	K3083	60
U5137-O-200S-NHB.....	54	UQFP-M-200	57	K3441	60
U5138-O-200S-NHB.....	54	Q115.....	58	K3442	60
U5139-O-200S-NHB.....	54	Q120.....	58	K8180	60
U5701-O-100S.....	55	Q125.....	58	K984	60
U5701-O-150S.....	55	Q130.....	58	M5-144	60
U5701-O-200S.....	55	Q135.....	58	5T8K2	61
U4908-O-100MB-11GR.....	56	Q140.....	58	BL7474	61
U4908-O-11GR.....	56	Q150.....	58	K1190	61
U5101-XL-100MB-11GR	56	Q160.....	58	K1190	61
U5101-XL-11GR.....	56	Q170.....	58	K3356	61
UQFB-100.....	57	Q2100.....	58	K3865	61
UQFB-100-X1	57	Q2125.....	58	K4977-EXT	61
UQFB-125.....	57	Q215.....	58	K4977-INT	61
UQFB-125-X1	57	Q220.....	58	K5022-INT	61
UQFB-150.....	57	Q225.....	58	K5T	61
UQFB-150-X1	57	Q230.....	58	Z802965-AC	61
UQFB-175.....	57	Q235.....	58	Z901925-AC	61
UQFB-175-X1	57	Q240.....	58	Z904486-AO	61
UQFB-200.....	57	Q250.....	58		
UQFB-200-X1	57	Q260.....	58		
UQFBH-100.....	57	Q270.....	58		
UQFBH-125.....	57	Q280.....	58		

Please consult serving utility for their requirements prior to ordering or installing, as specifications and approvals vary by utility, and may require local electrical inspector approval. All installations must be installed by a licensed electrician and must comply with all national and local codes, laws and regulations. Milbank reserves the right to make changes in specifications and features shown without notice or obligation.



MILBANK
ENERGY AT WORK

Please consult serving utility for their requirements prior to ordering or installing, as specifications and approvals vary by utility, and may require local electrical inspector approval. All installations must be installed by a licensed electrician and must comply with all national and local codes, laws and regulations. Milbank reserves the right to make changes in specifications and features shown without notice or obligation.



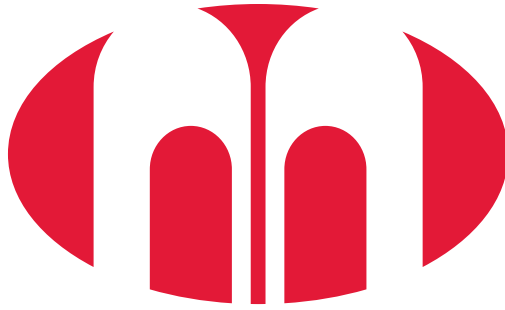

MILBANK®

ENERGY AT WORK

REPRESENTED BY

HOLBROOK-ASSOCIATED

Electrical Manufacturer's Representatives



P.O. Box 401 • 35 Reservoir Park Dr., Rockland, MA 02370
781-871-0011 • 1-800-322-9641 • Fax: 1-781-871-2956
www.holbrook-associated.com

